

OS2  
40

disegnare le  
trasparenze  
drawing the  
transparencies





# OS2 40

La massima qualità in un sistema ridotto all'essenziale. Studiati per i progetti di interior design, i profili tubolari, agili e leggeri, riproducono nelle partizioni vetrate la stessa immagine dei serramenti OS2 a taglio termico, creando un effetto di continuità fra interno ed esterno dell'edificio.

*The maximum quality in a system reduced to the essentials: OS2 40. Designed for interior design projects, the agile and lightweight tubular profiles reproduce the same image of the OS2 windows and doors in the glass partitions, creating an effect of continuity between interiors and the building envelope.*

OS2 40 + OS2 75



porta scorrevole con vetri singoli  
*sliding door with single glass*



porta due ante  
*double sashes door*





porta ad un'anta  
*single sash door*



porta a due ante  
*double sashes door*

# OS2 40

sezioni a vista da 12 a 47 mm,  
profondità di soli 42 mm e vetri  
fino a 27 mm.

*the visible sections range from  
12 to 47 mm while the depth is  
reduced to 42 mm, for glazing  
up to 27 mm.*

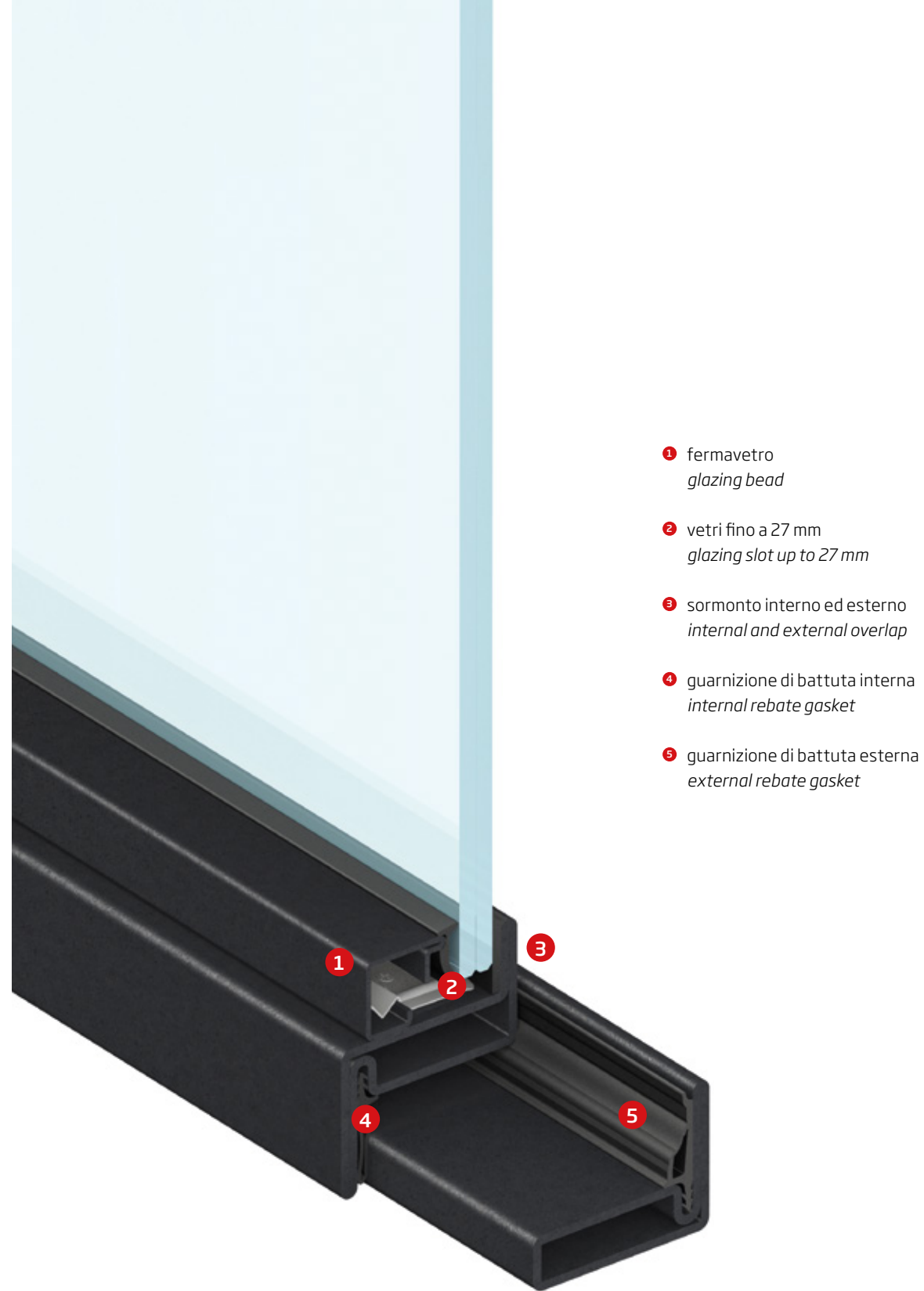
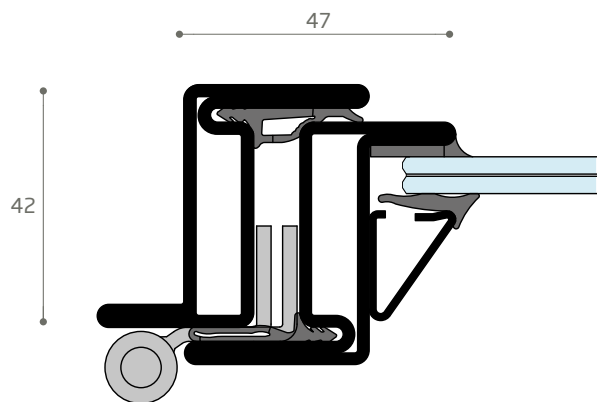

# OS2 40

## tipologie di apertura porte *openings doors*

apertura interna  
*inward opening*

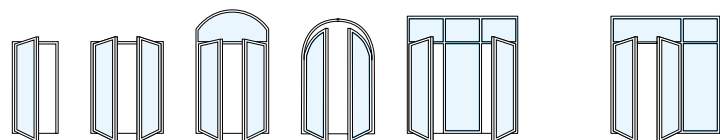

apertura esterna  
*outward opening*

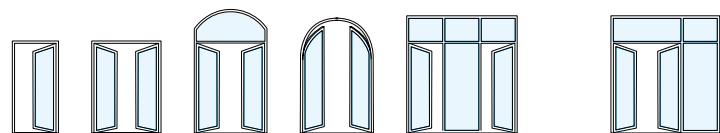

## materiali *materials*

acciaio decapato  
(verniciato)  
*pickled steel*  
(*painted*)

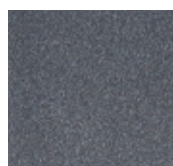

## maniglie *handles*

### VITRUVIO tronca

finiture  
*finishes*

ottone naturale | brunito | verniciato  
*natural brass | burnished | painted*

Corten  
*Cor-ten*



### VITRUVIO quadra

finiture  
*finishes*

ottone naturale | brunito | verniciato  
*natural brass | burnished | painted*

Corten  
*Cor-ten*





OS2 40 vista esterna | *external view*



OS2 40 vista interna | *internal view*



# OS2 40

## nodi sections

apertura interna  
*inward opening*

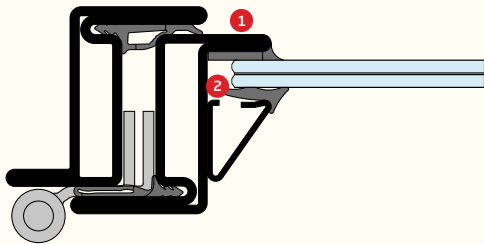

1 sormonto interno ed esterno  
*internal and external overlap*

2 camera per vetri fino a 27 mm  
*fitting groove up to 27 mm*

apertura esterna  
*outward opening*

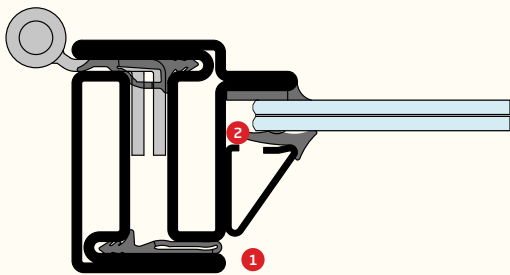

1 sormonto interno ed esterno  
*internal and external overlap*

2 camera per vetri fino a 27 mm  
*fitting groove up to 27 mm*

## profili profiles

PR2424

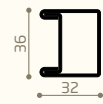

PR2425

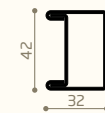

PR2430

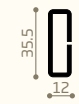

PR2431

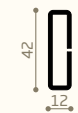

PR2451

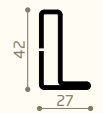

PR2461

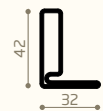

PR2462

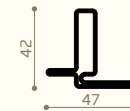

PR2463

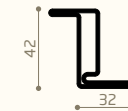

PR2464

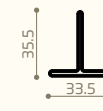

PR2471

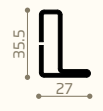

PR2454

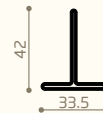

PR2455

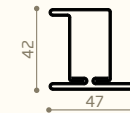

PR2474

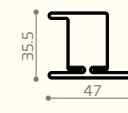

PR2482

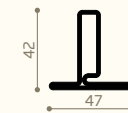

## fermavetri glazing beads

PR2415



PR2416



PR2429



PR2606



PR2607



# OS2 40

## sezioni sections

### apertura interna inward opening

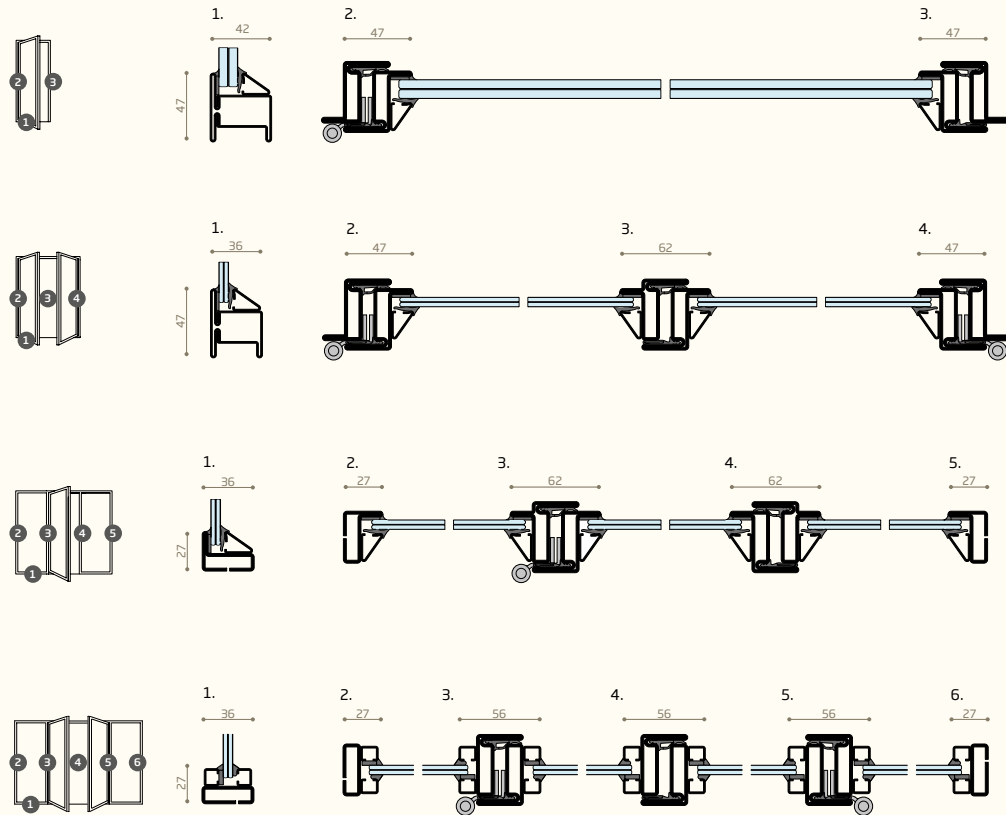

## sezioni sections

### apertura esterna outward opening

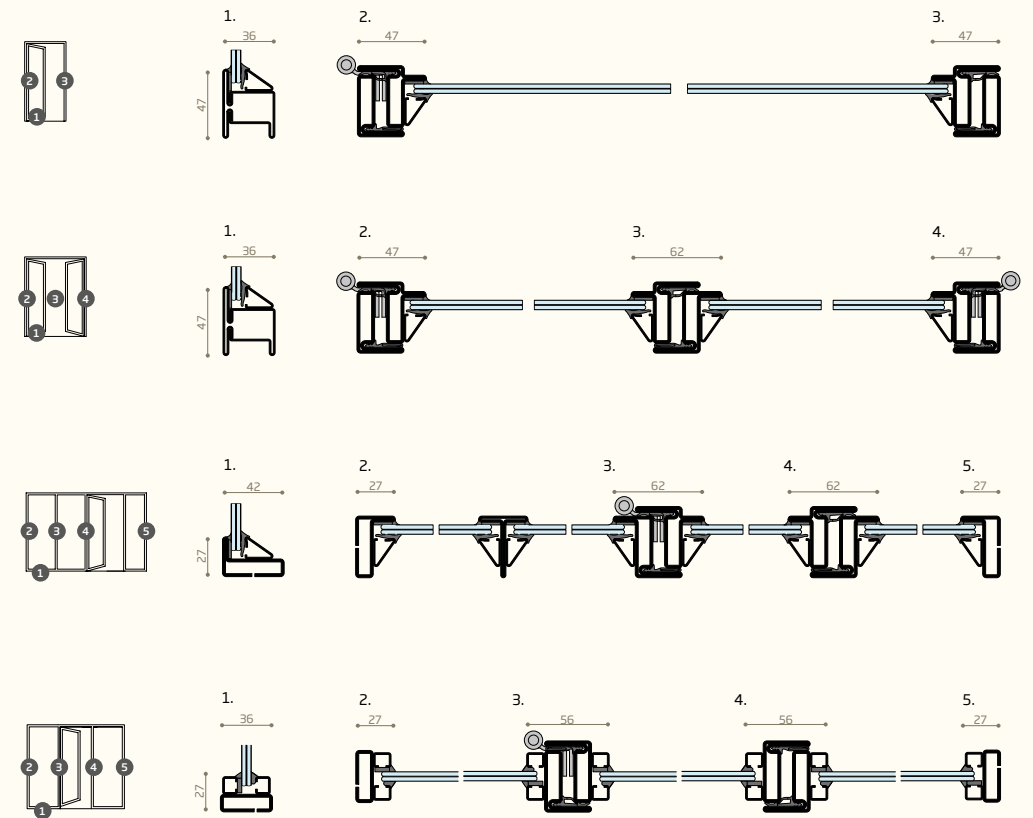





porta ad un'anta con fissi  
*single sash door with fixed pane*



fisso con dividivetro  
*fix door with divide profile*

Secco Sistemi S.p.A.

[www.seccosistemi.com](http://www.seccosistemi.com)

