

Wall Connection Detail

-

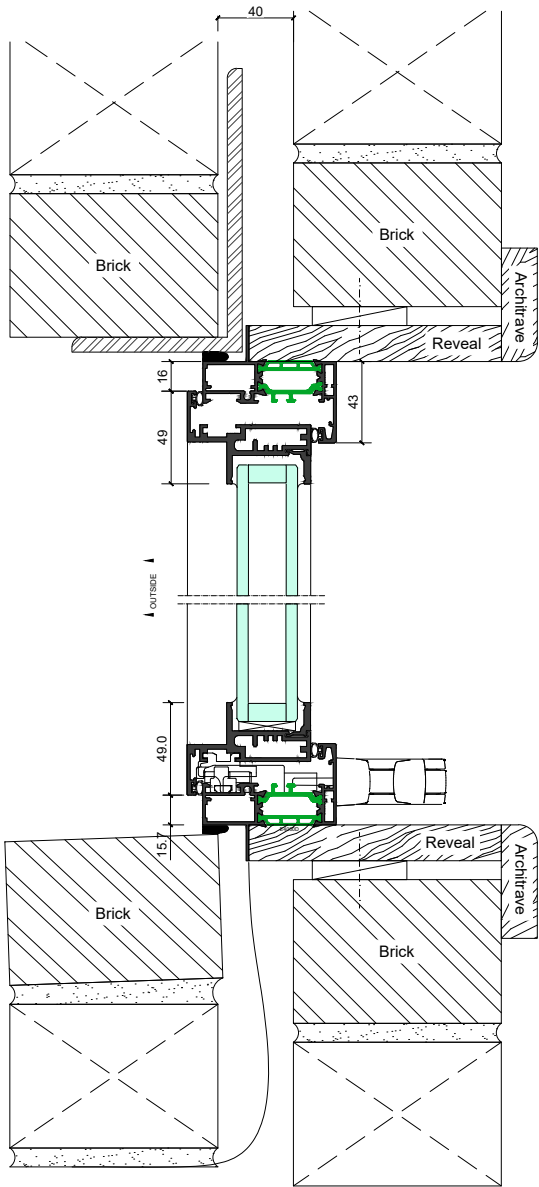

Elevation Section 1-1

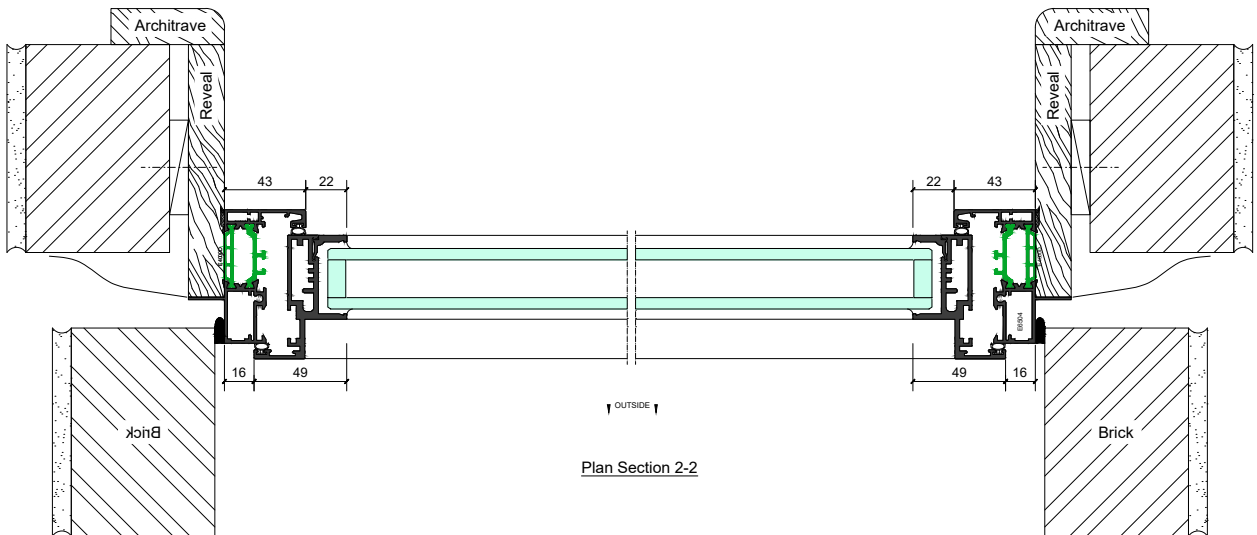
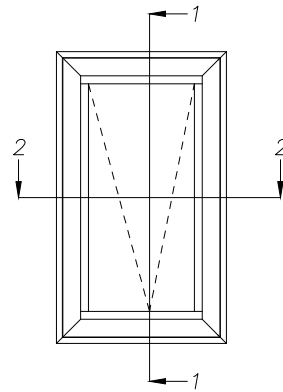

Plan Section 2-2

Wall Connection Detail

-

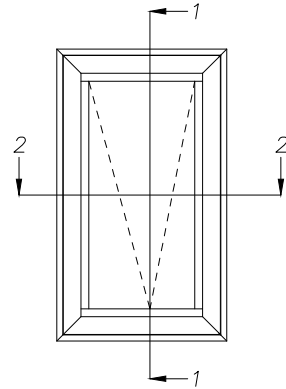
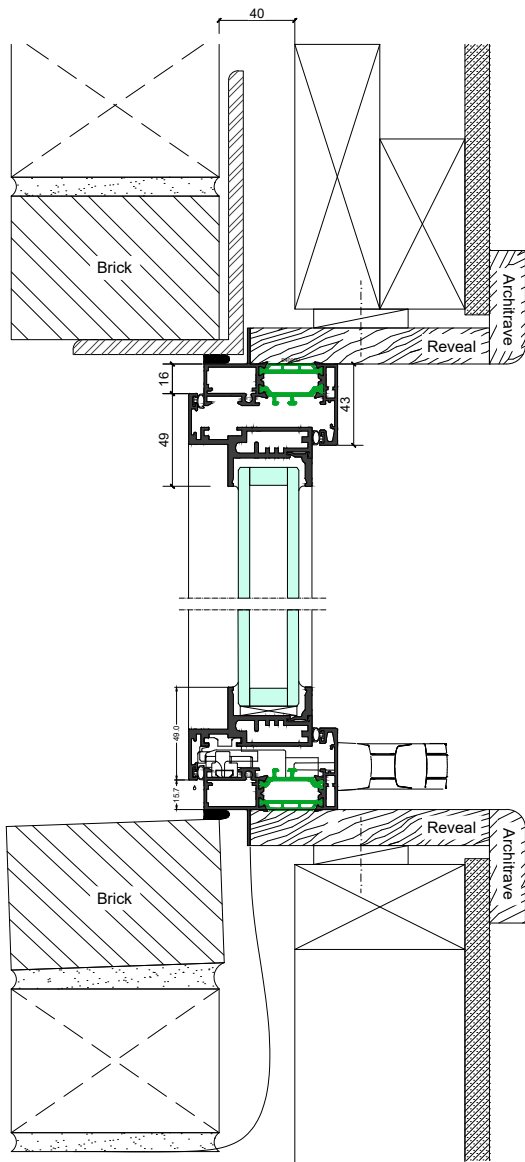

Elevation Section 1-1

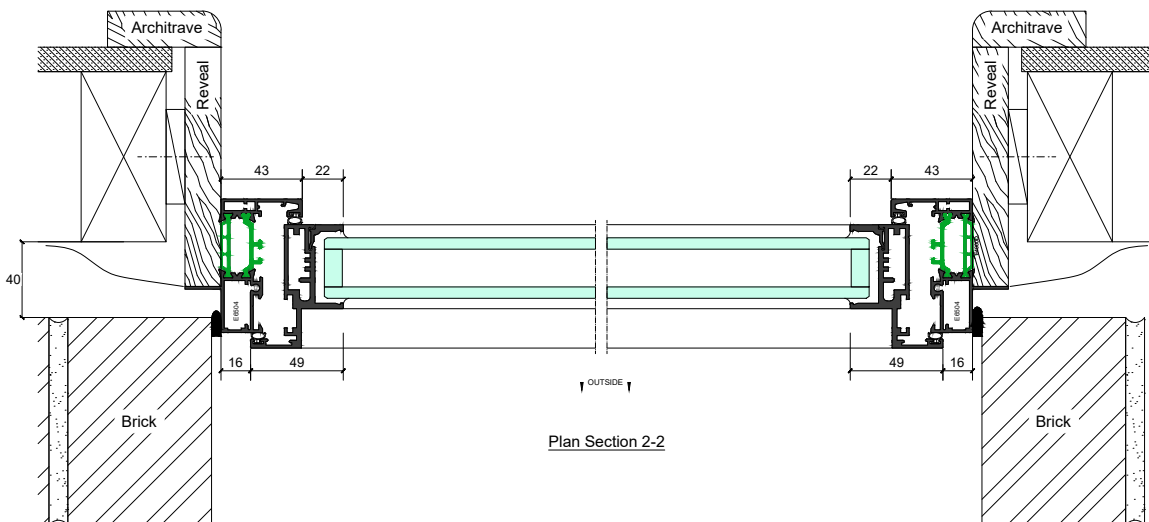

Plan Section 2-2

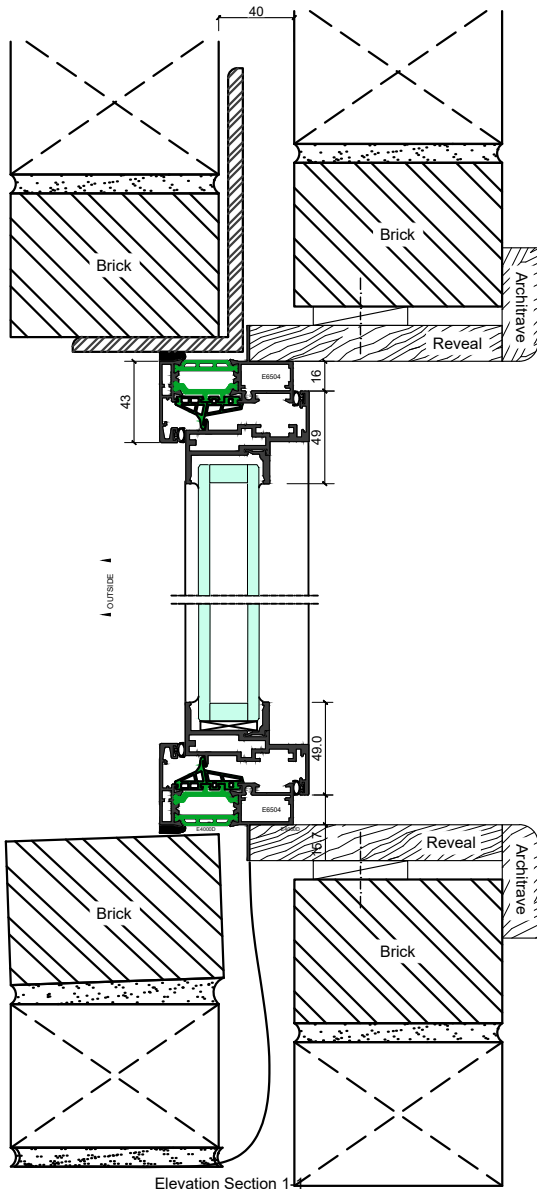

Elevation Section 1-1

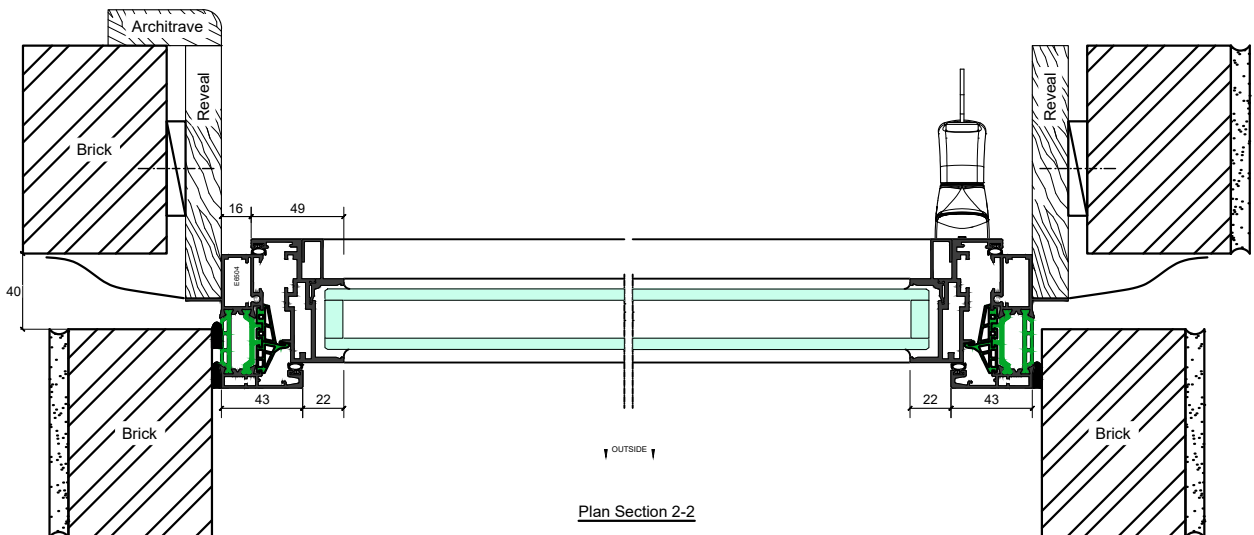
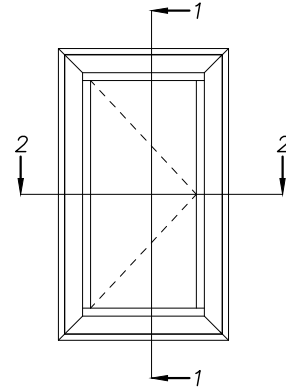

Plan Section 2-2

