

EC 115TB

LAYOUTS – XO CONFIGURATION

SLIDING DOOR

2 TRACKS

THERMECO™

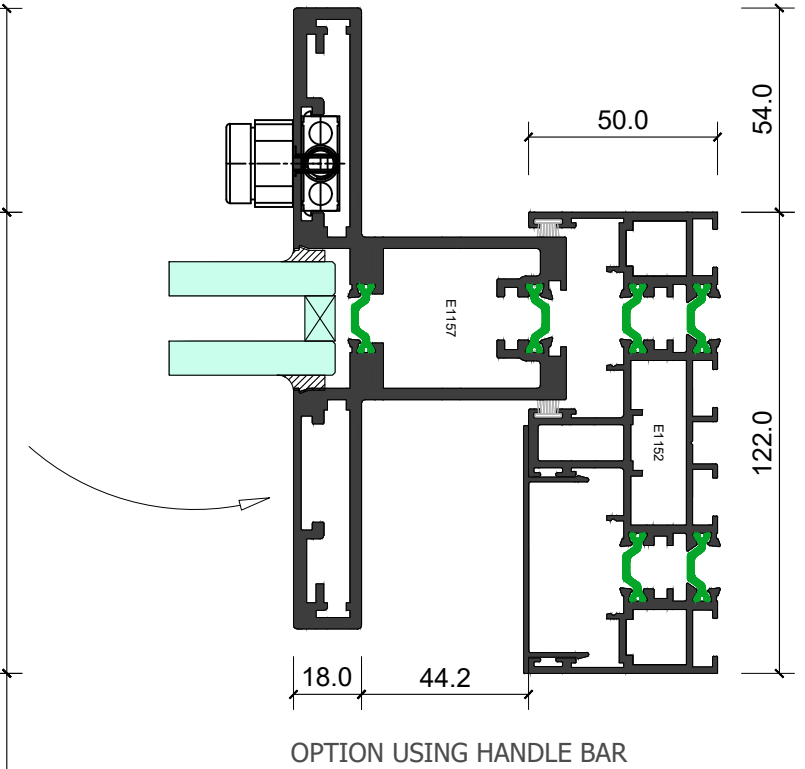
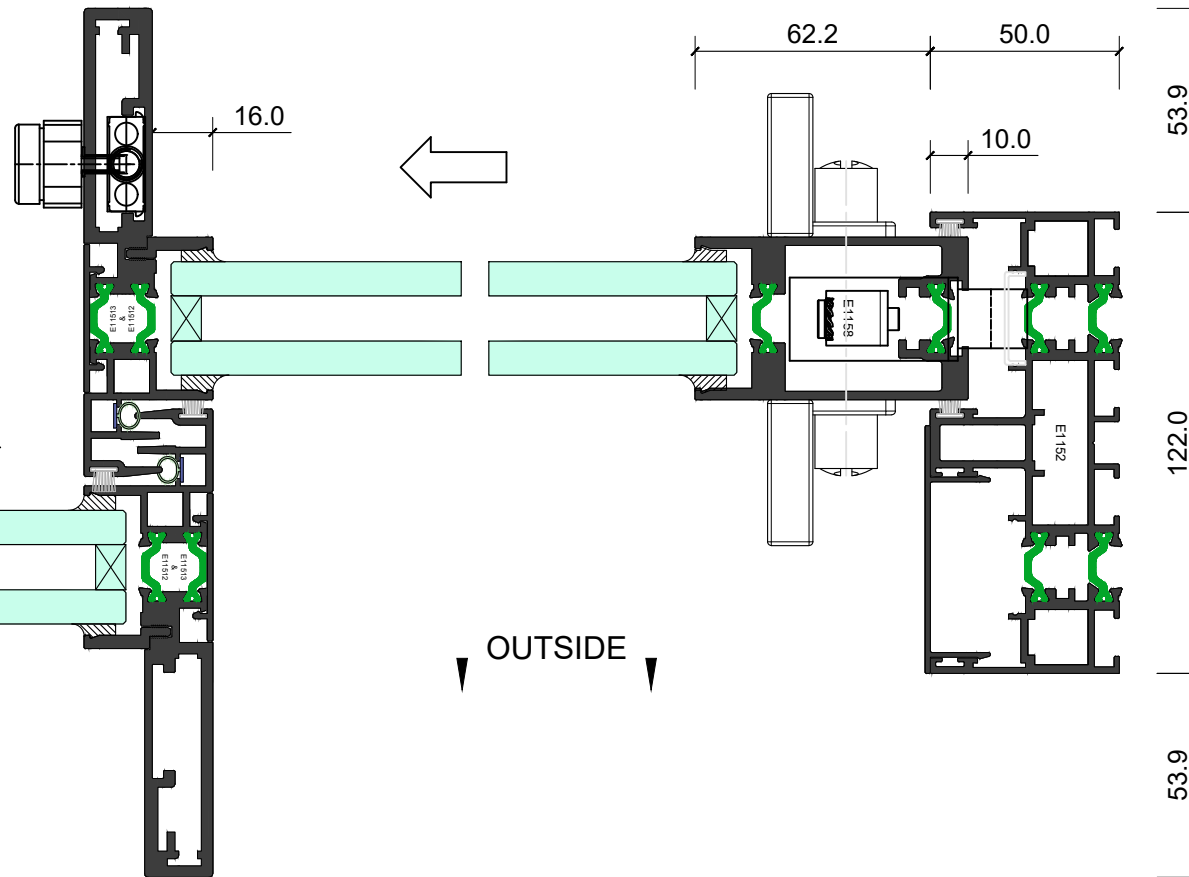
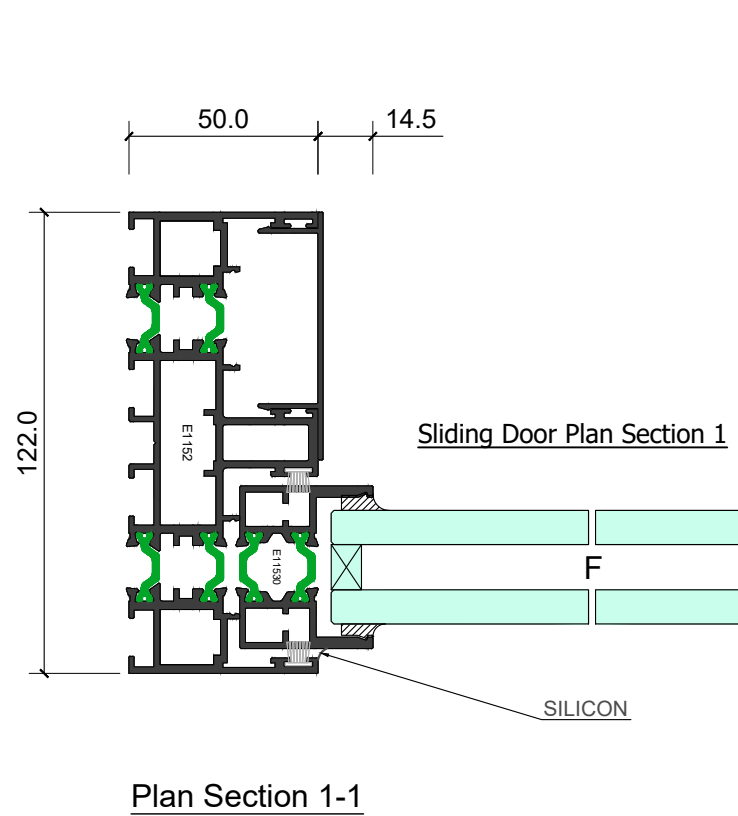
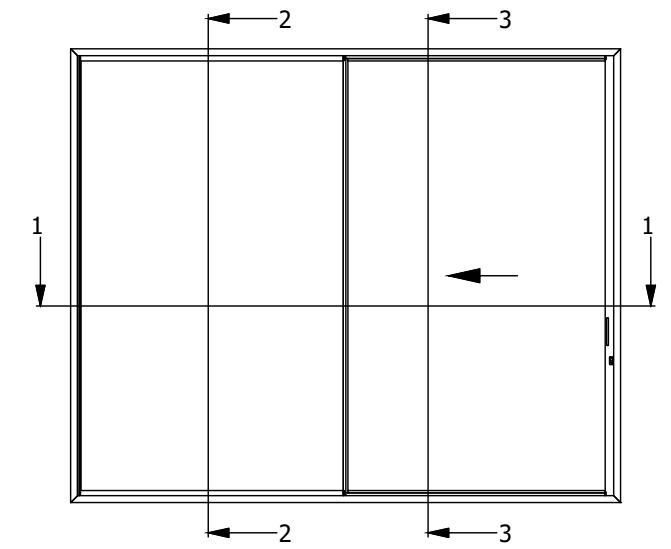
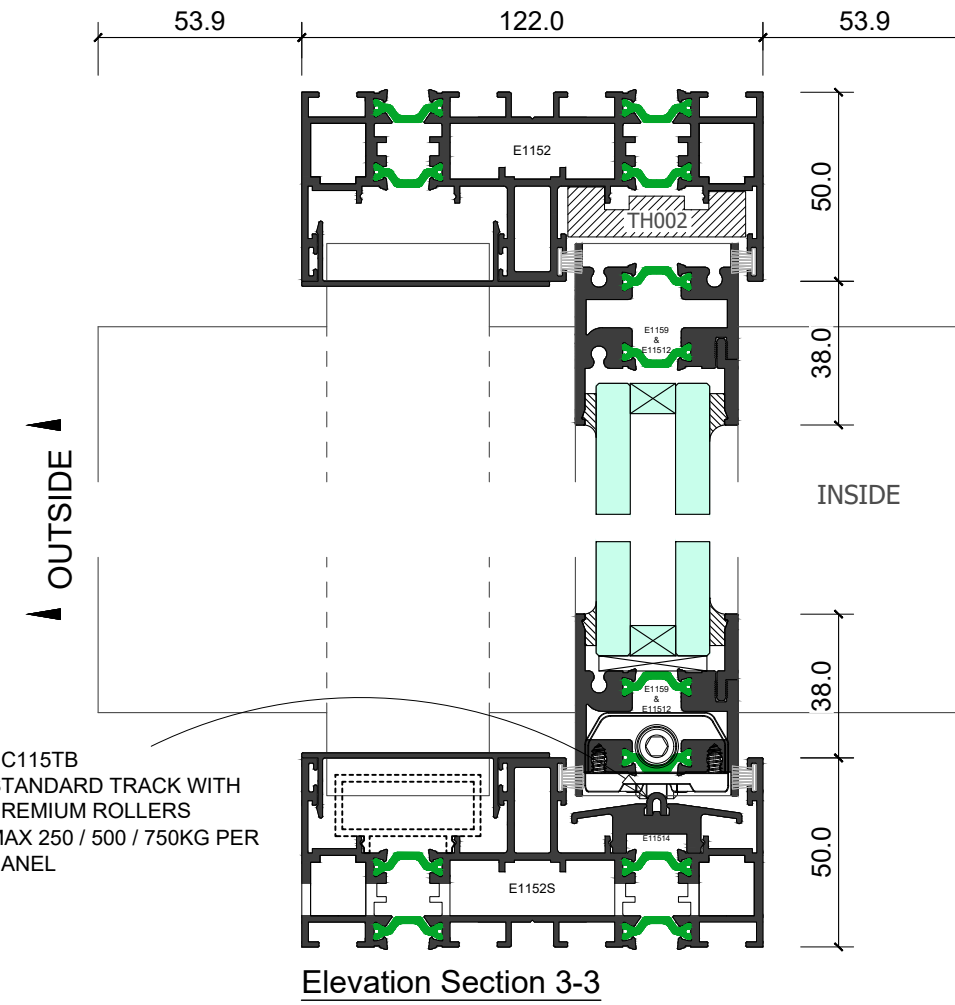
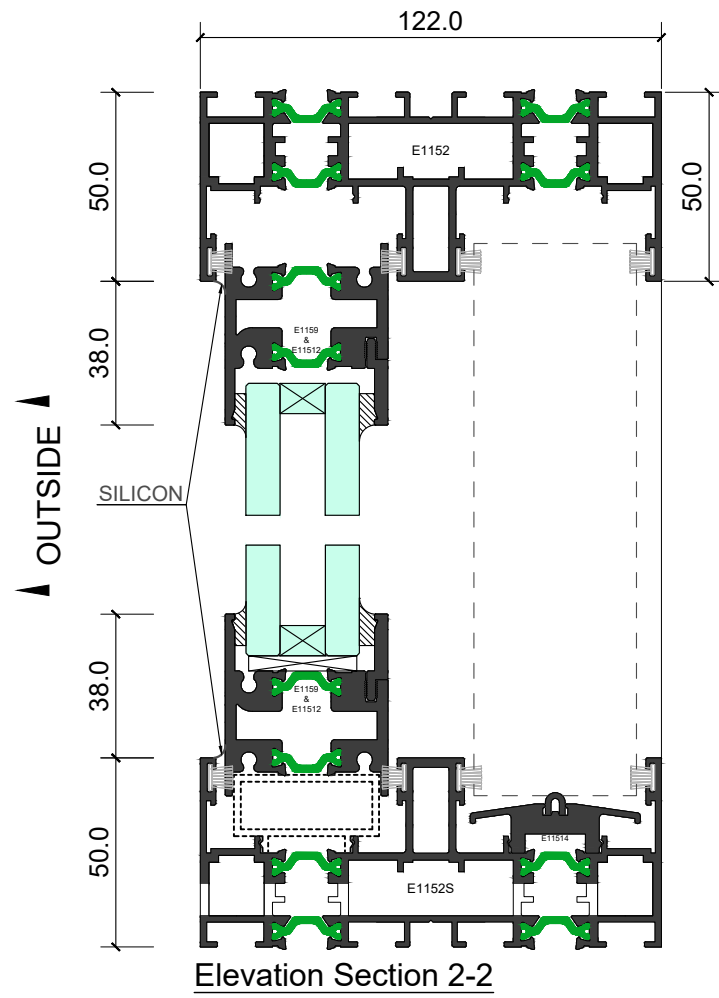

EC 115TB

LAYOUTS – OXX CONFIGURATION

SLIDING DOOR

3 TRACKS

THERMECO™

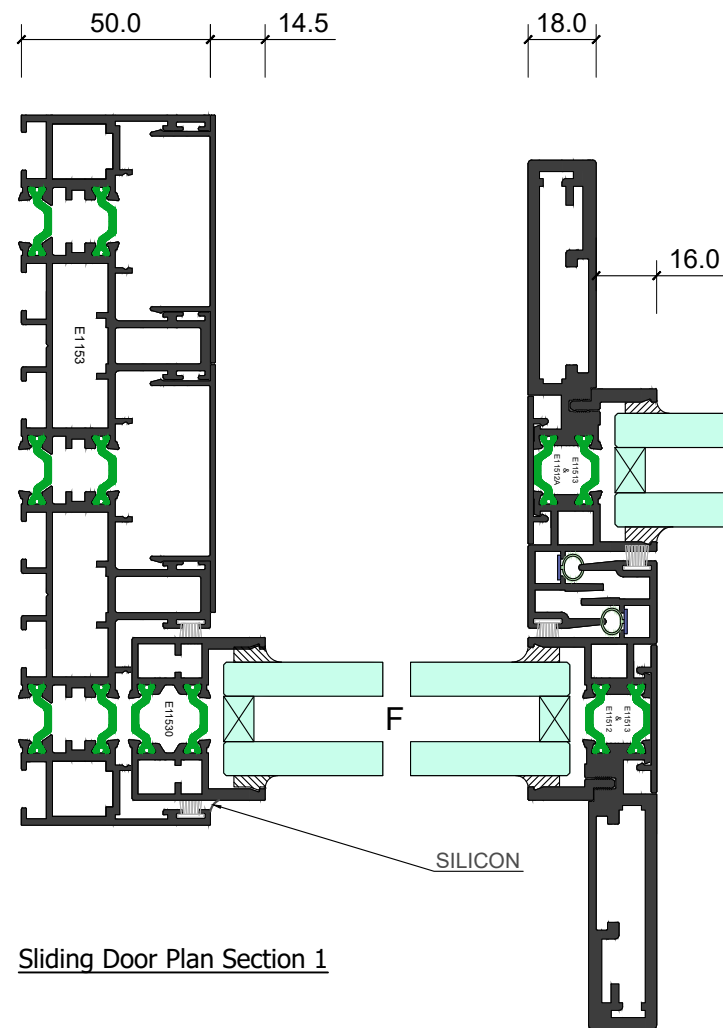
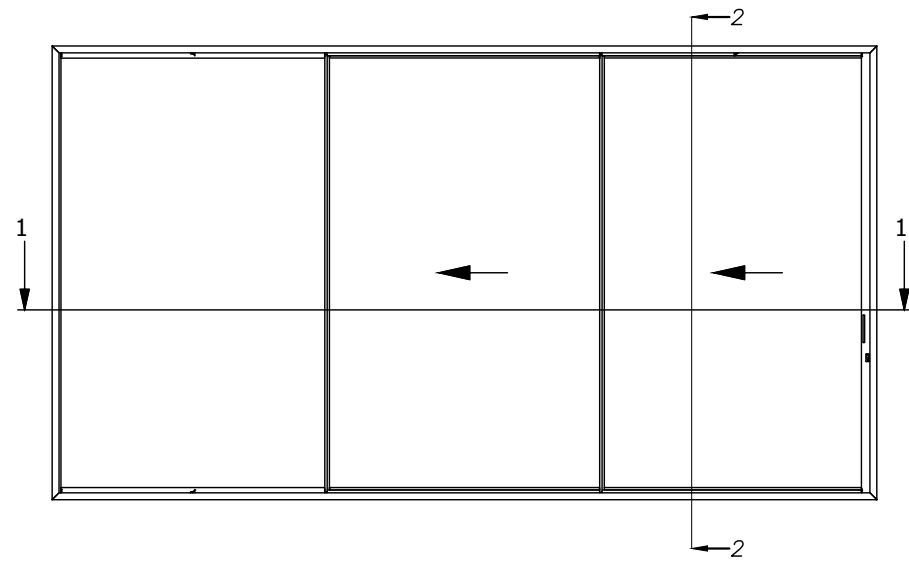

Sliding Door Plan Section 1

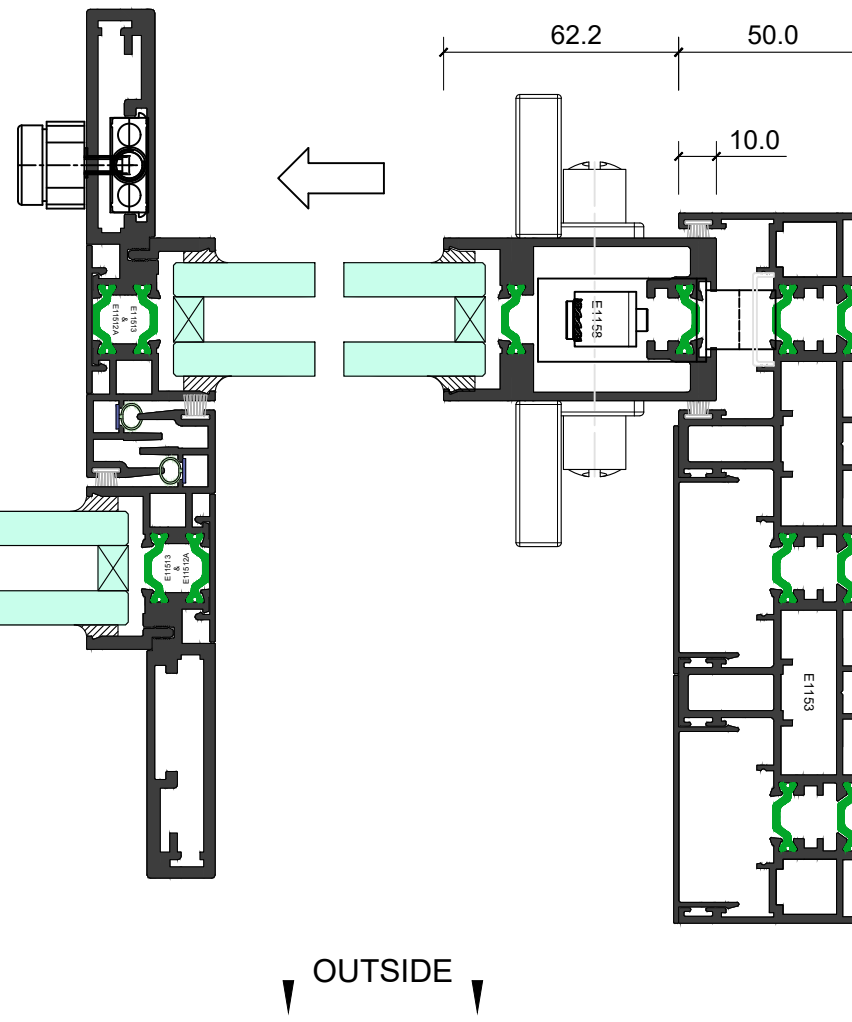

OUTSIDE

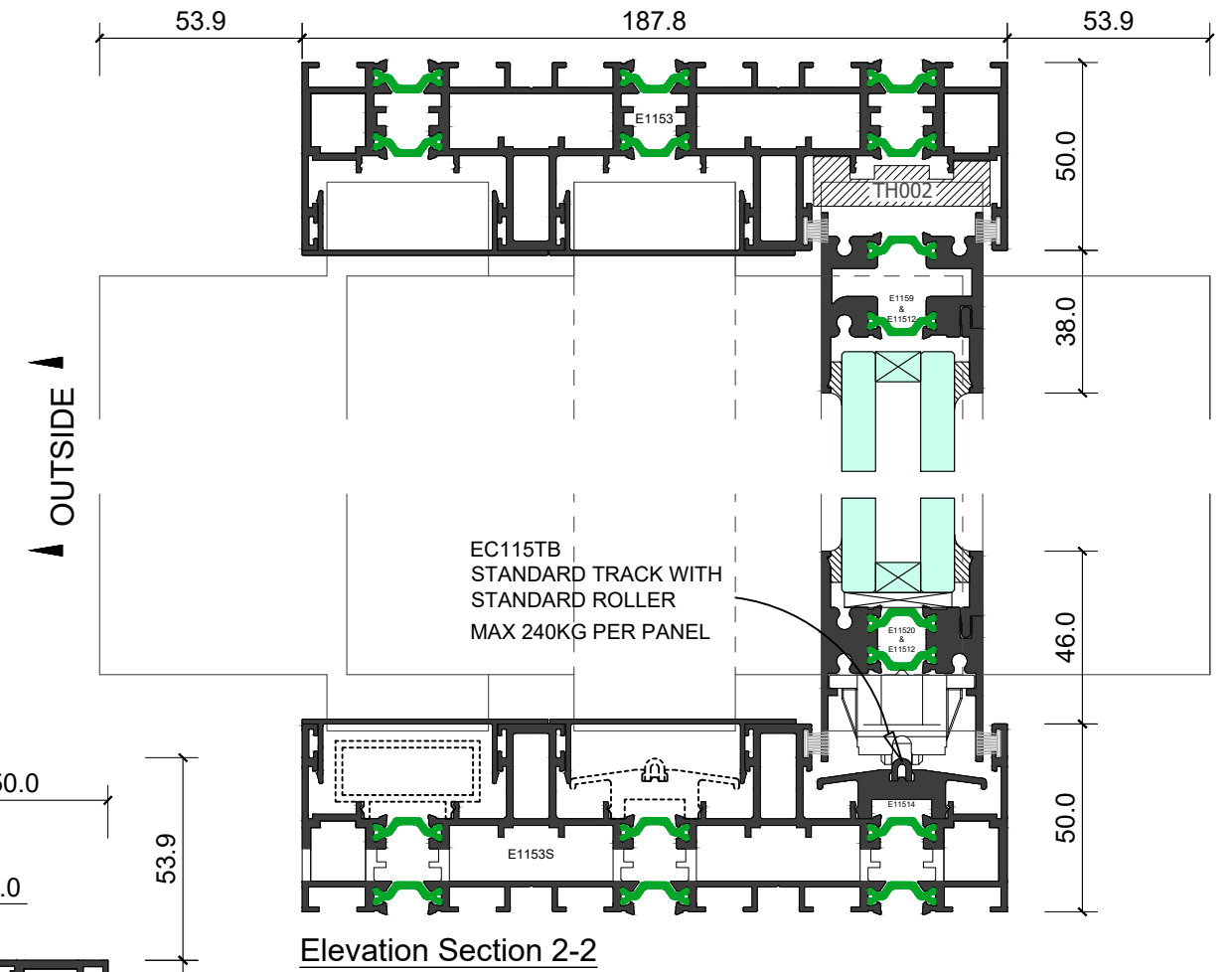

Elevation Section 2-2

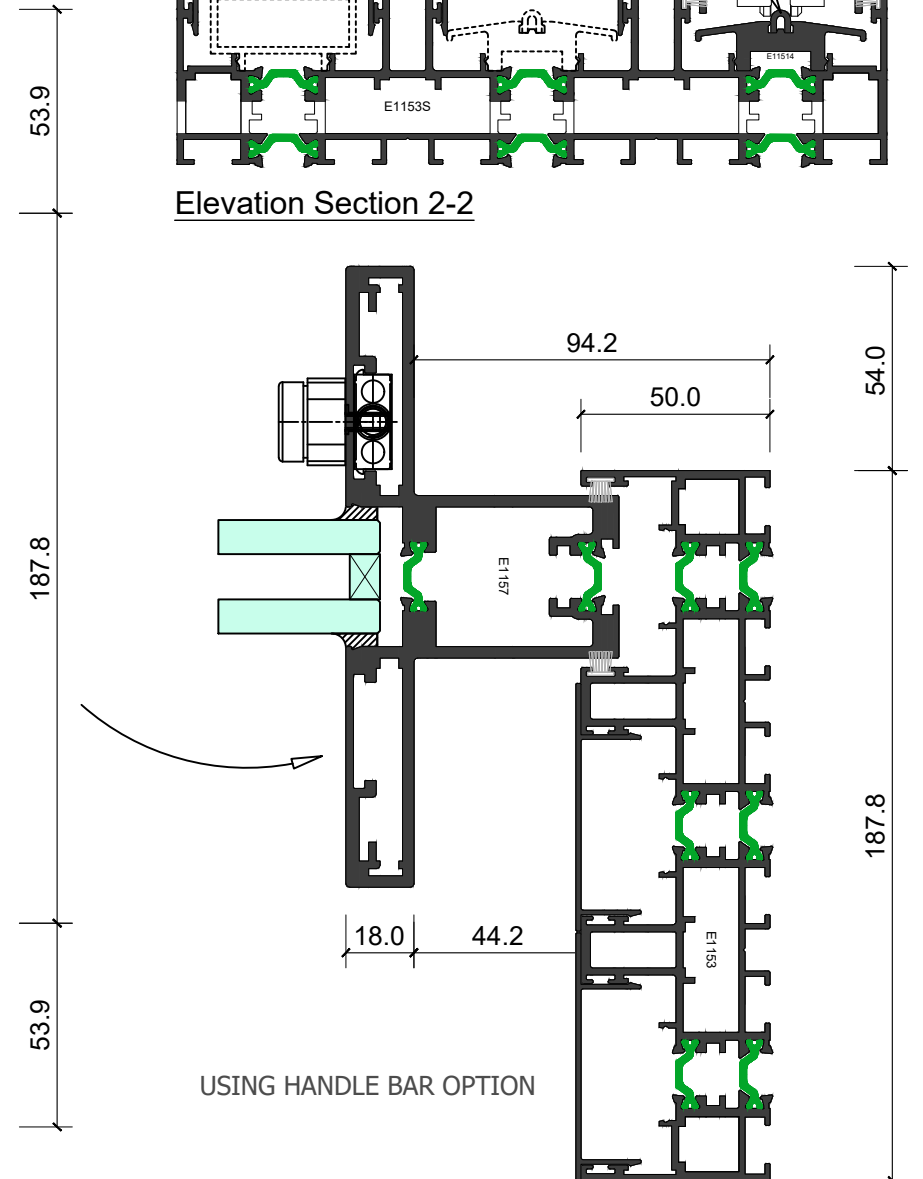

USING HANDLE BAR OPTION

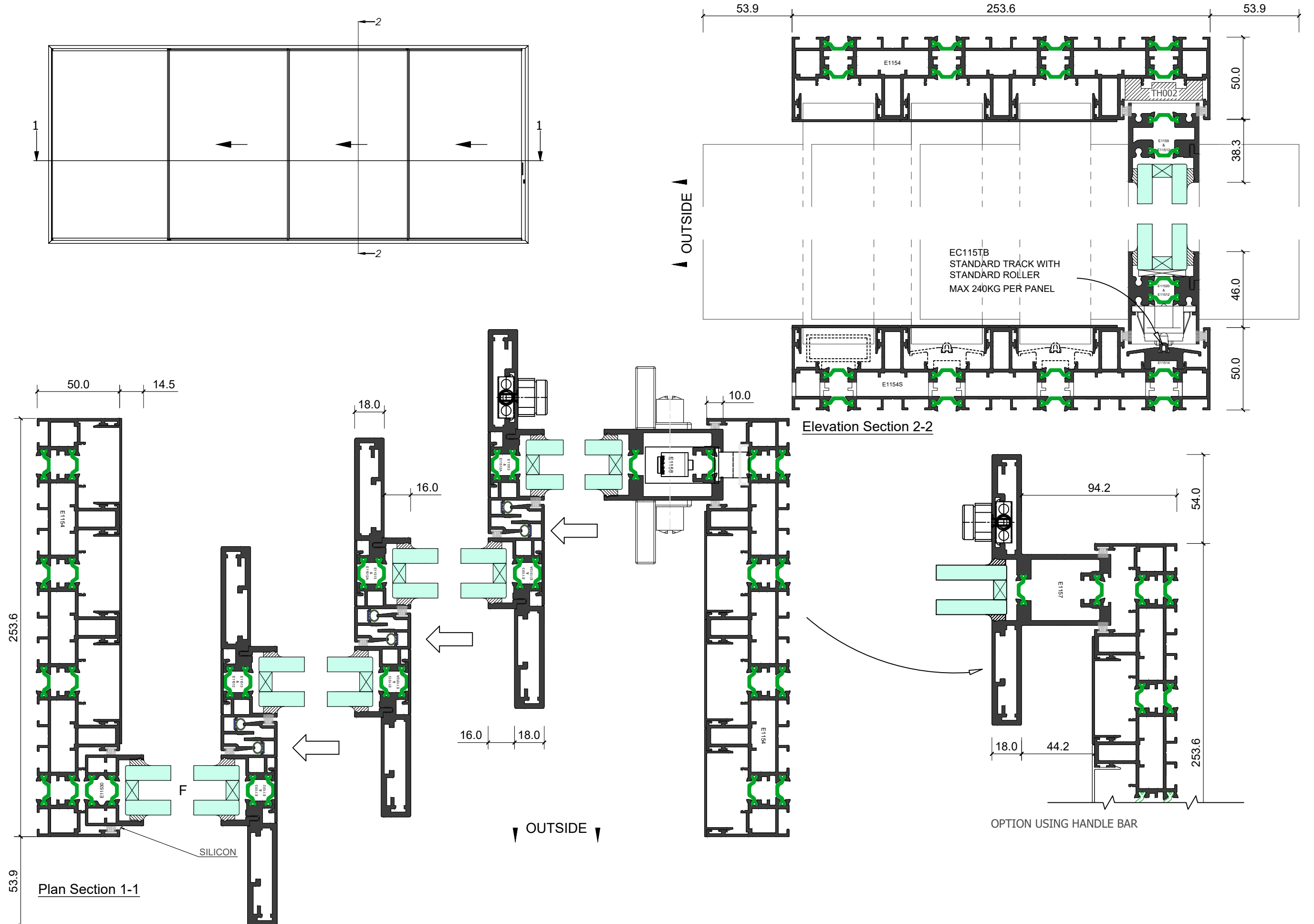

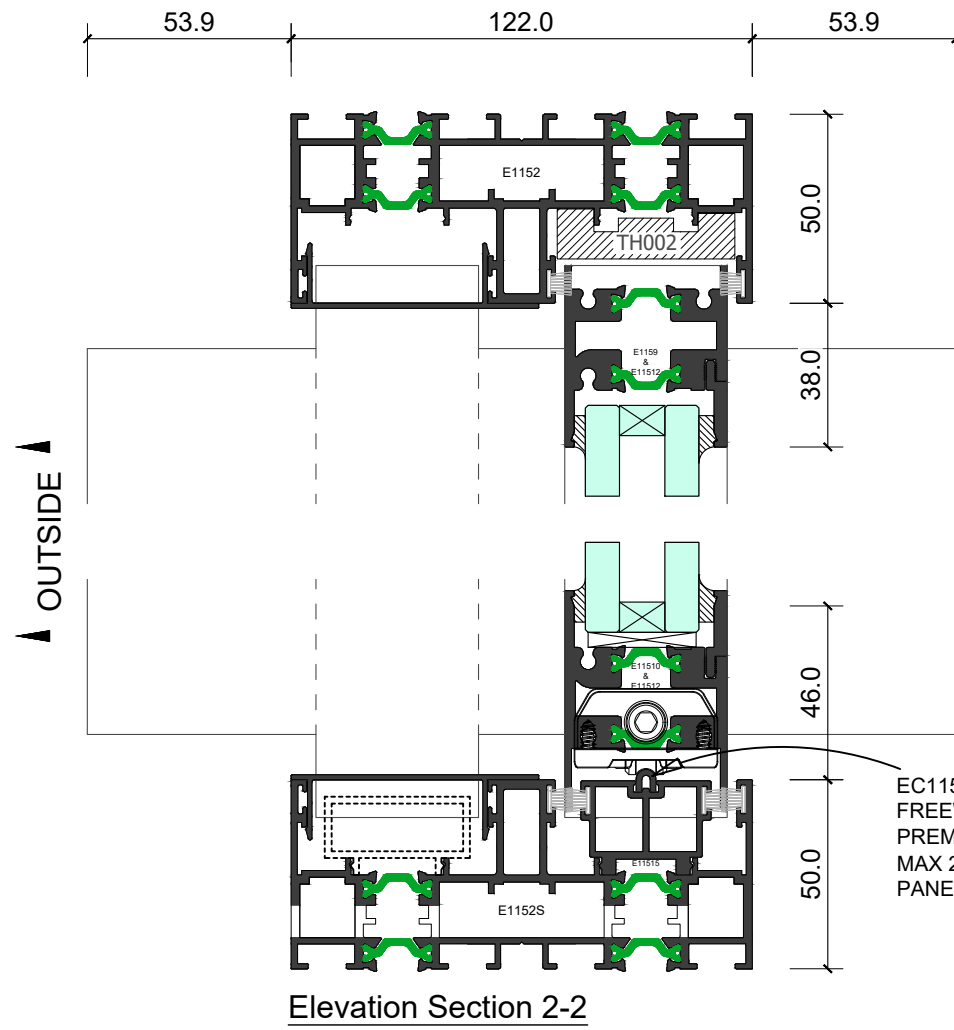

EC115TB
FREEWAY TRACK WITH
PREMIUM ROLLERS
MAX 250 / 500 / 750KG PER
PANEL

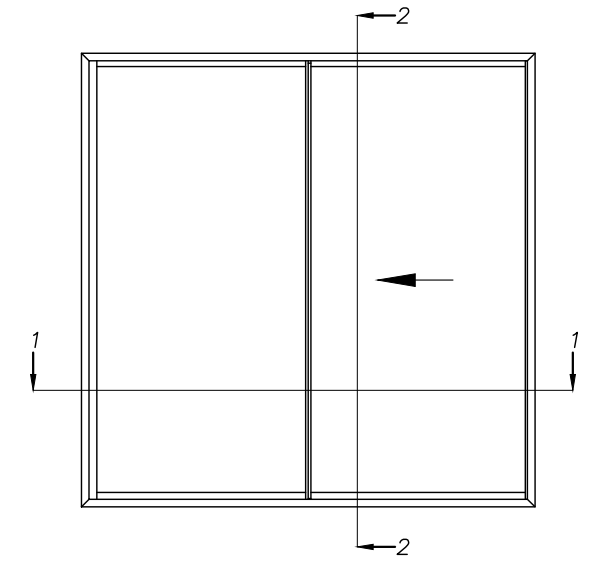
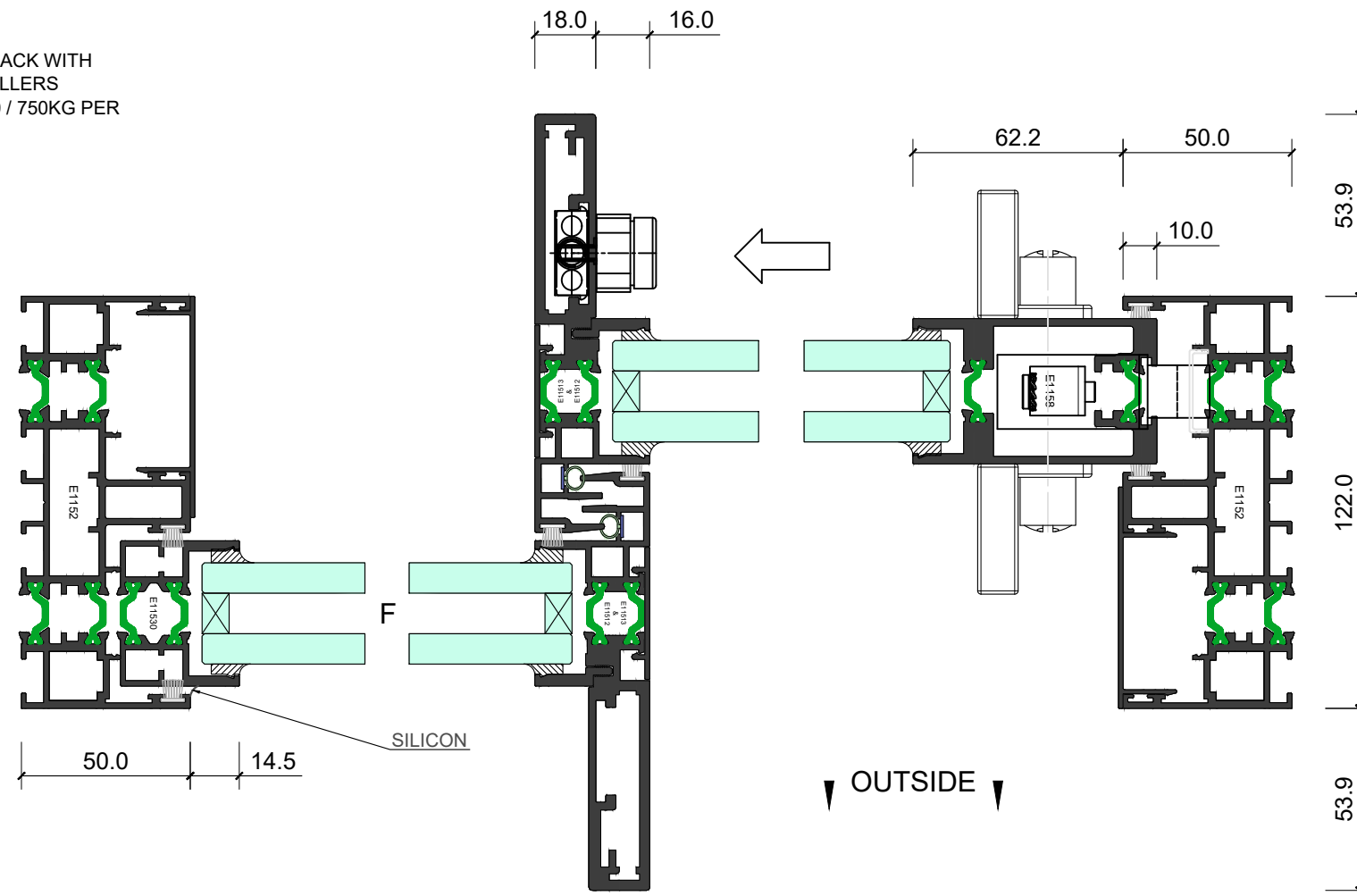

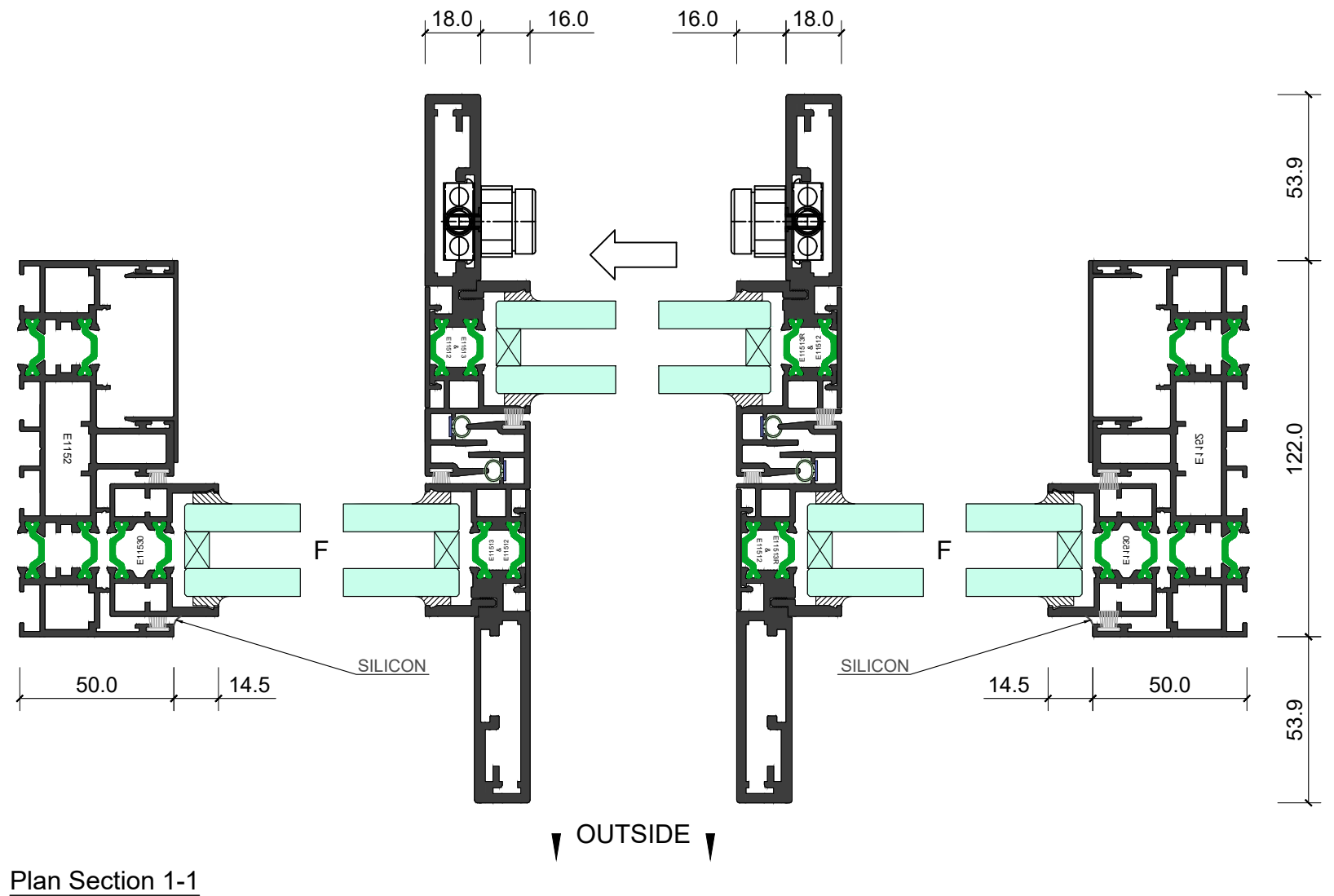
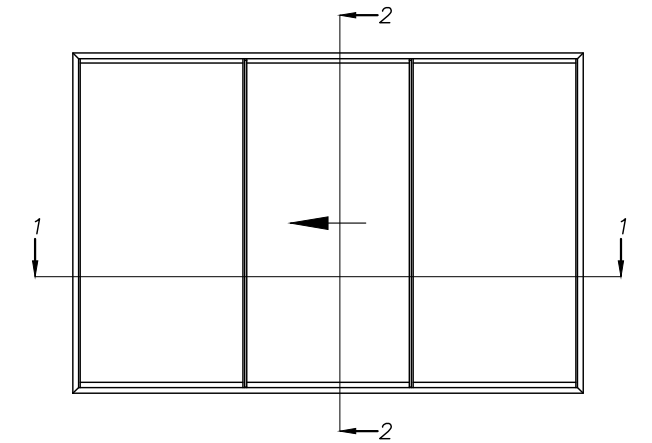
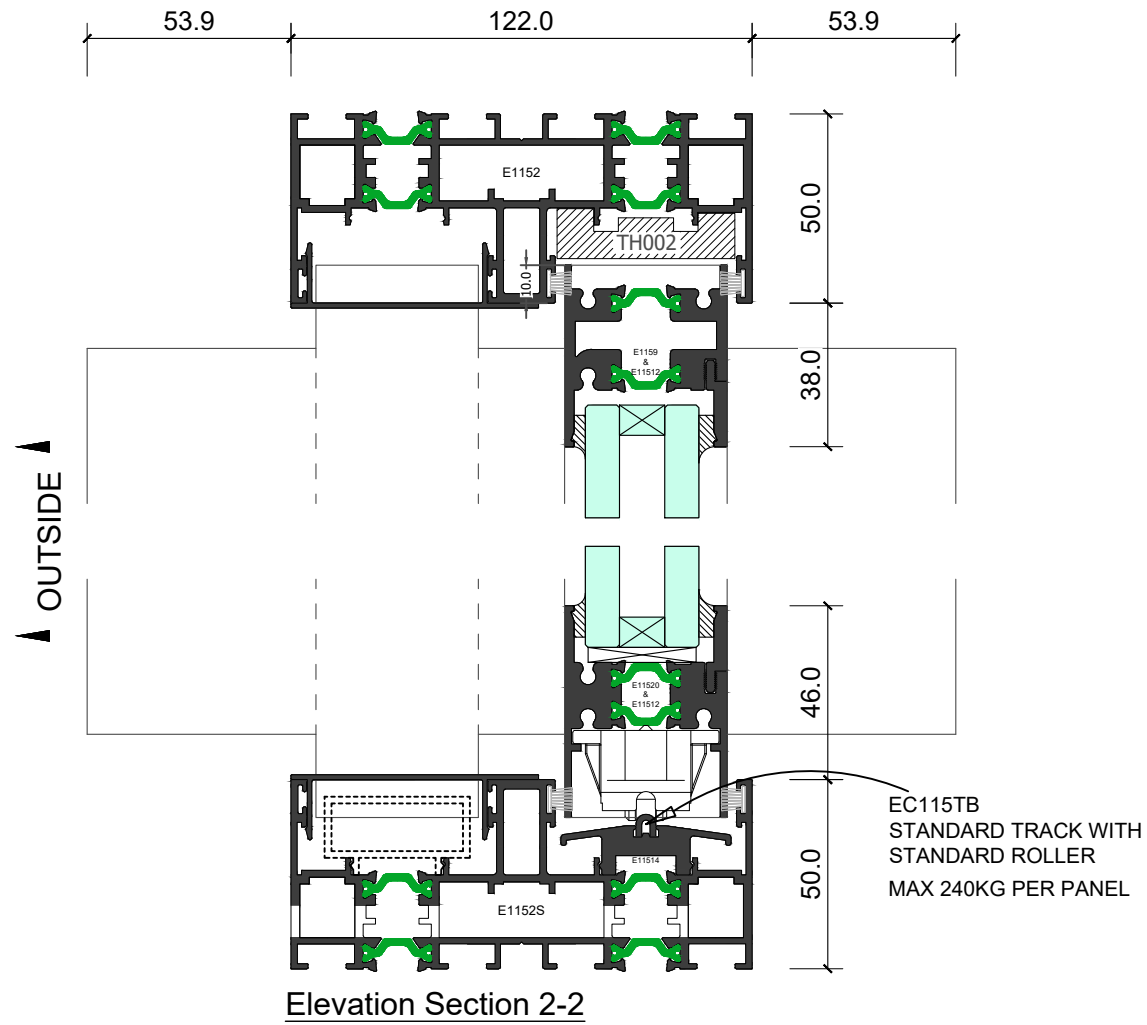

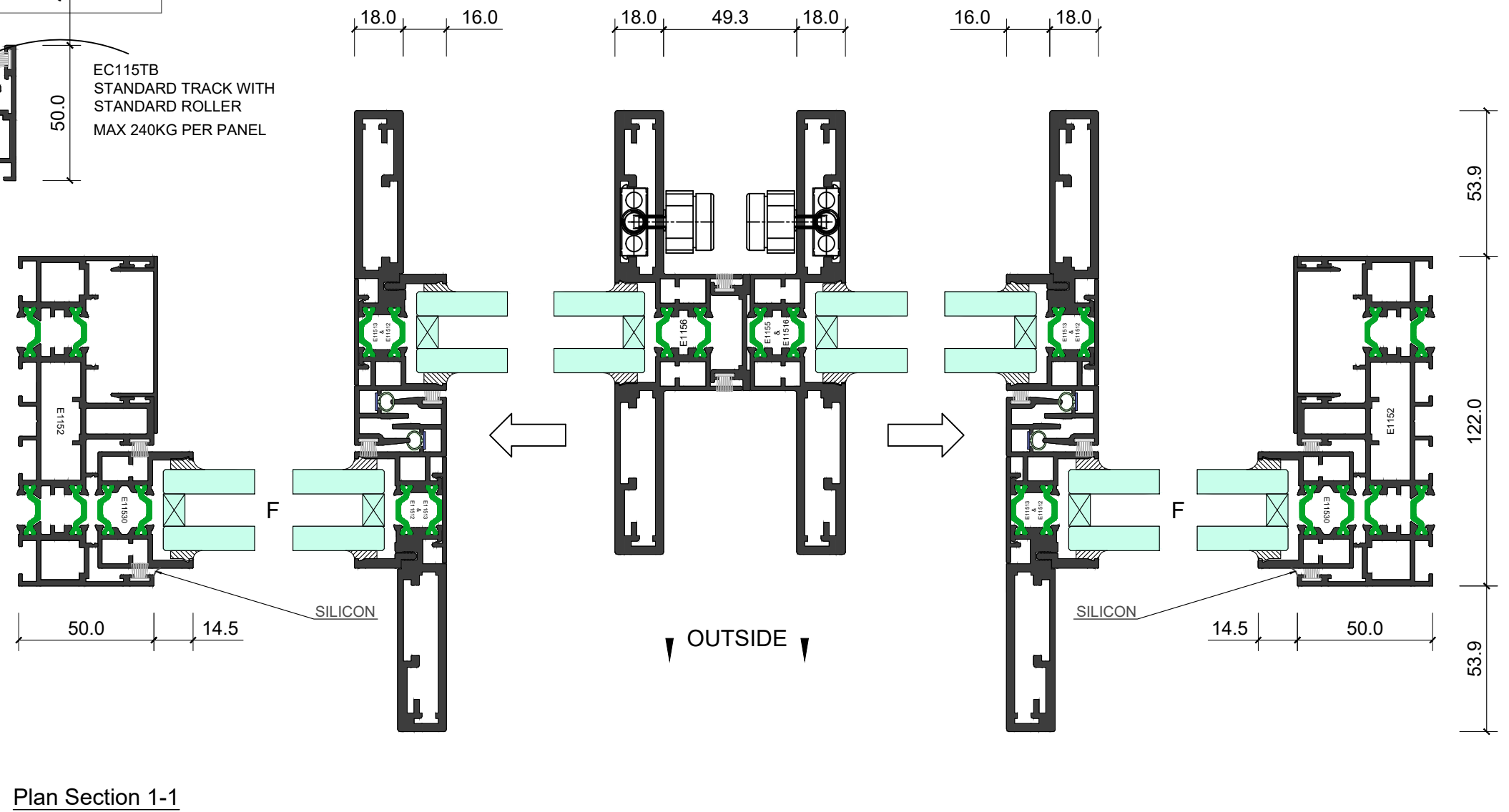
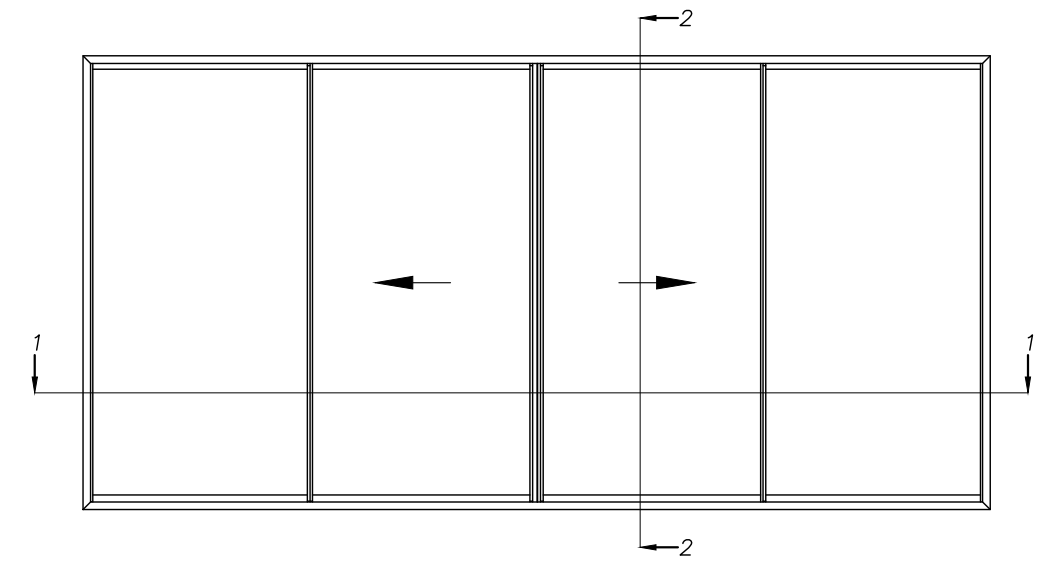
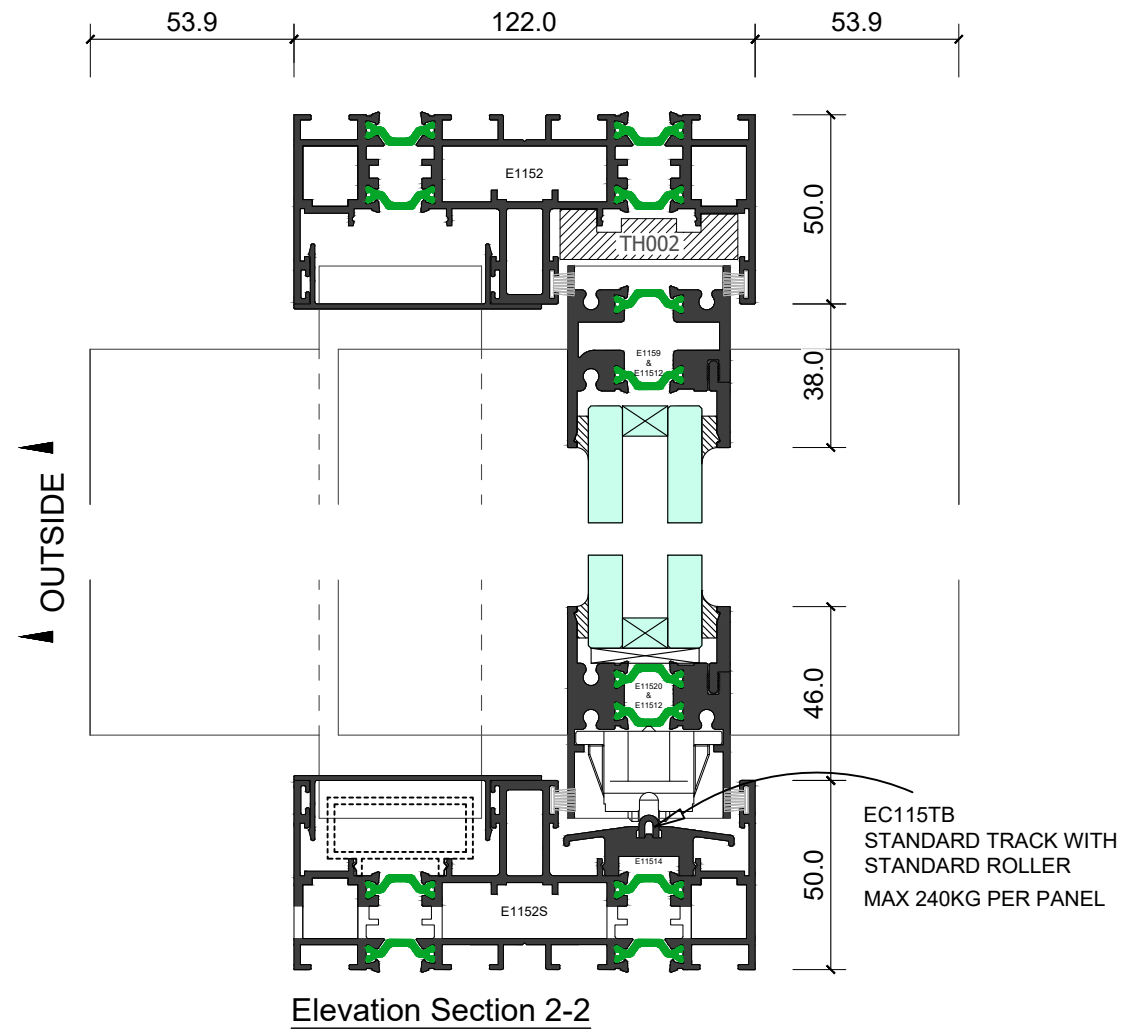

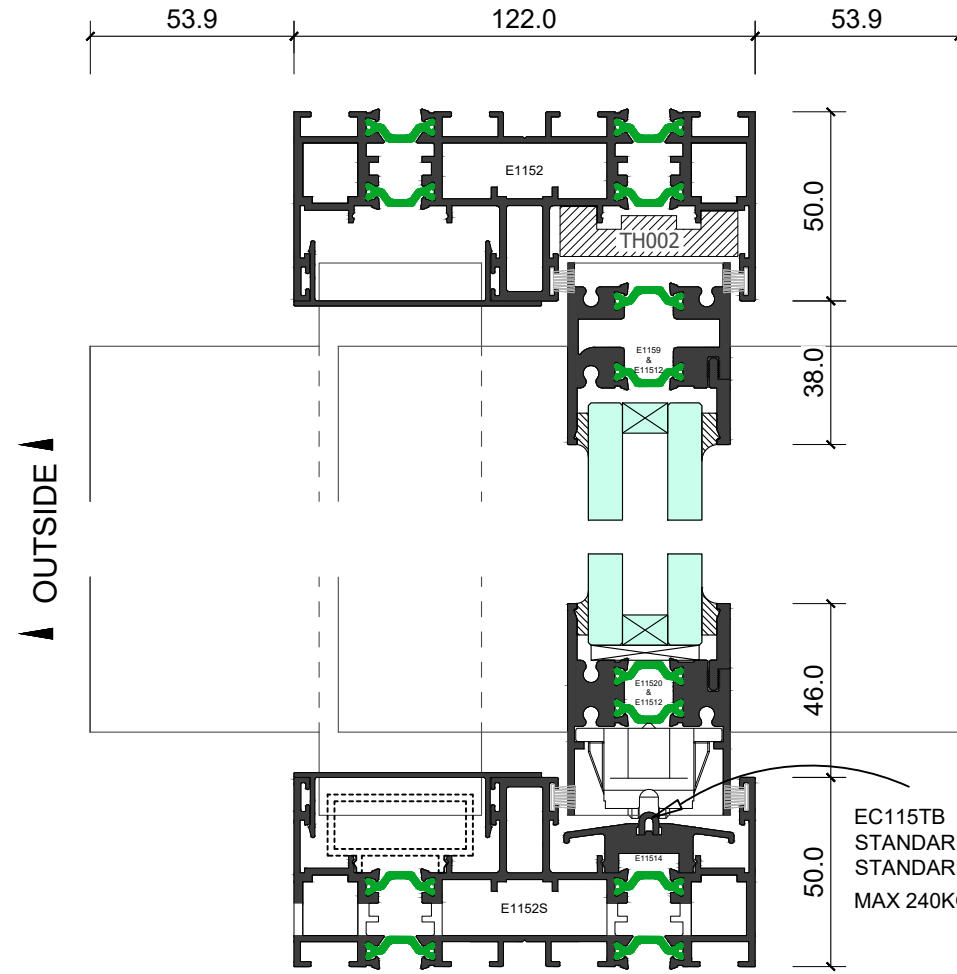

Elevation Section 2-2

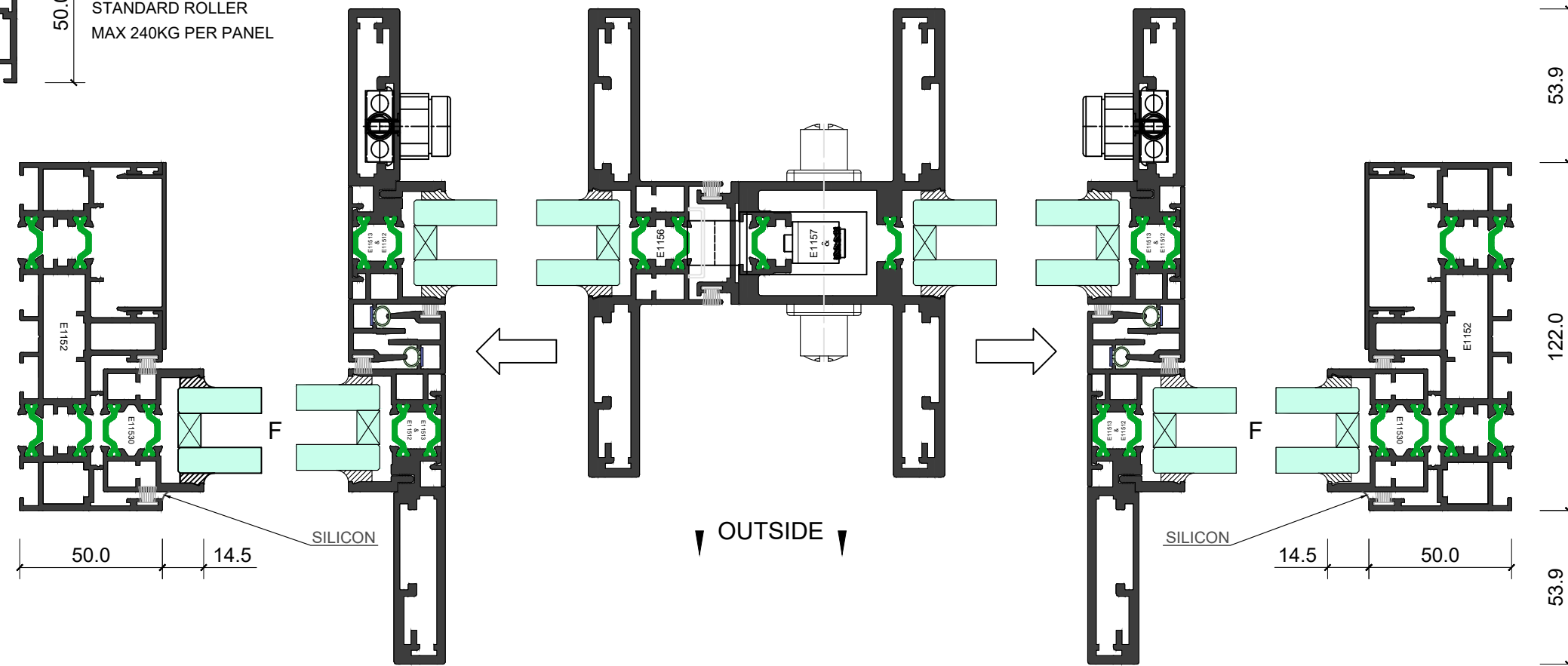
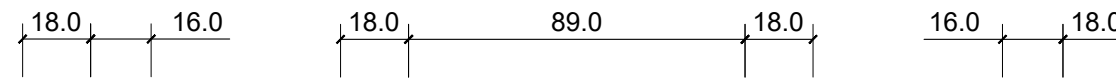
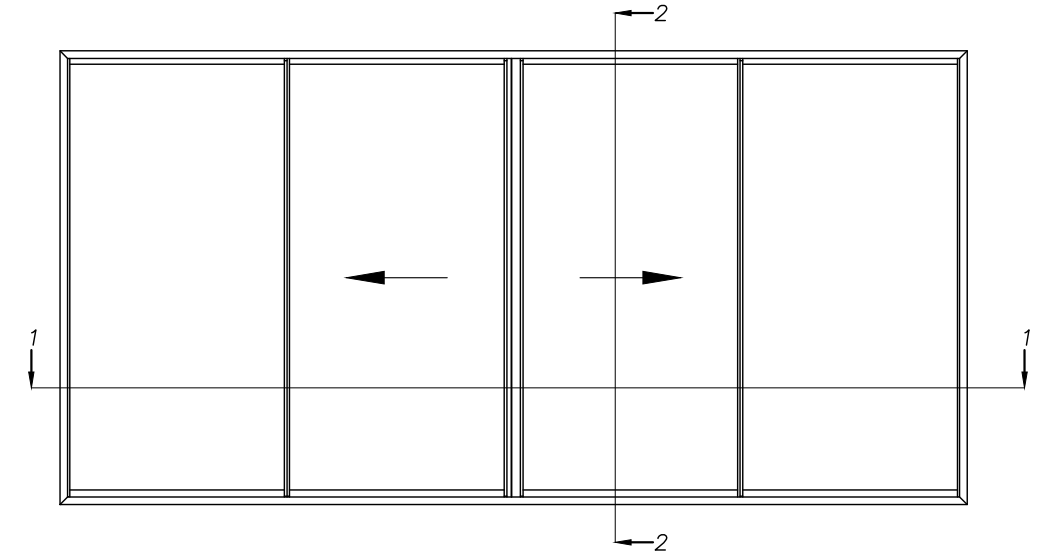

Plan Section 1-1

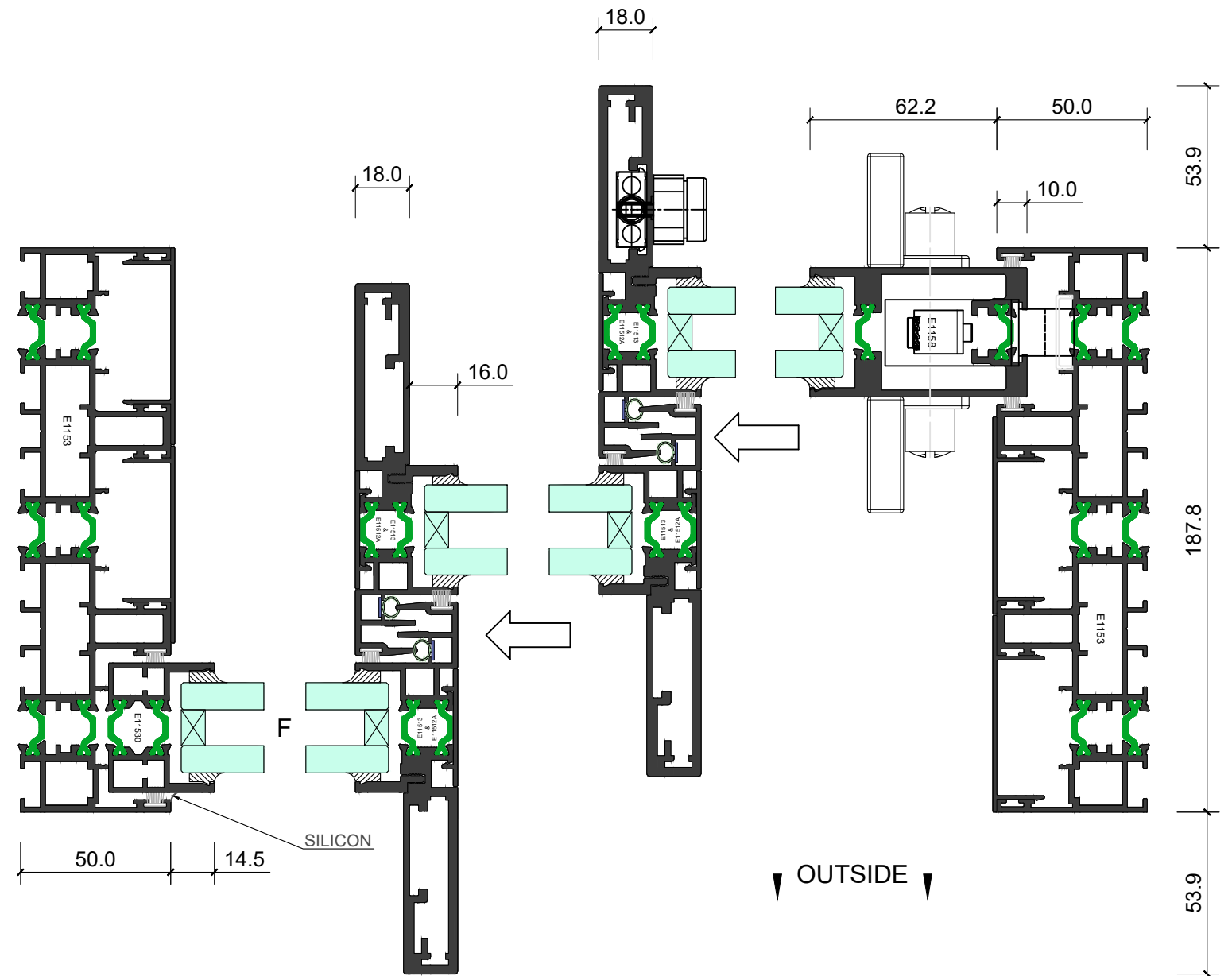
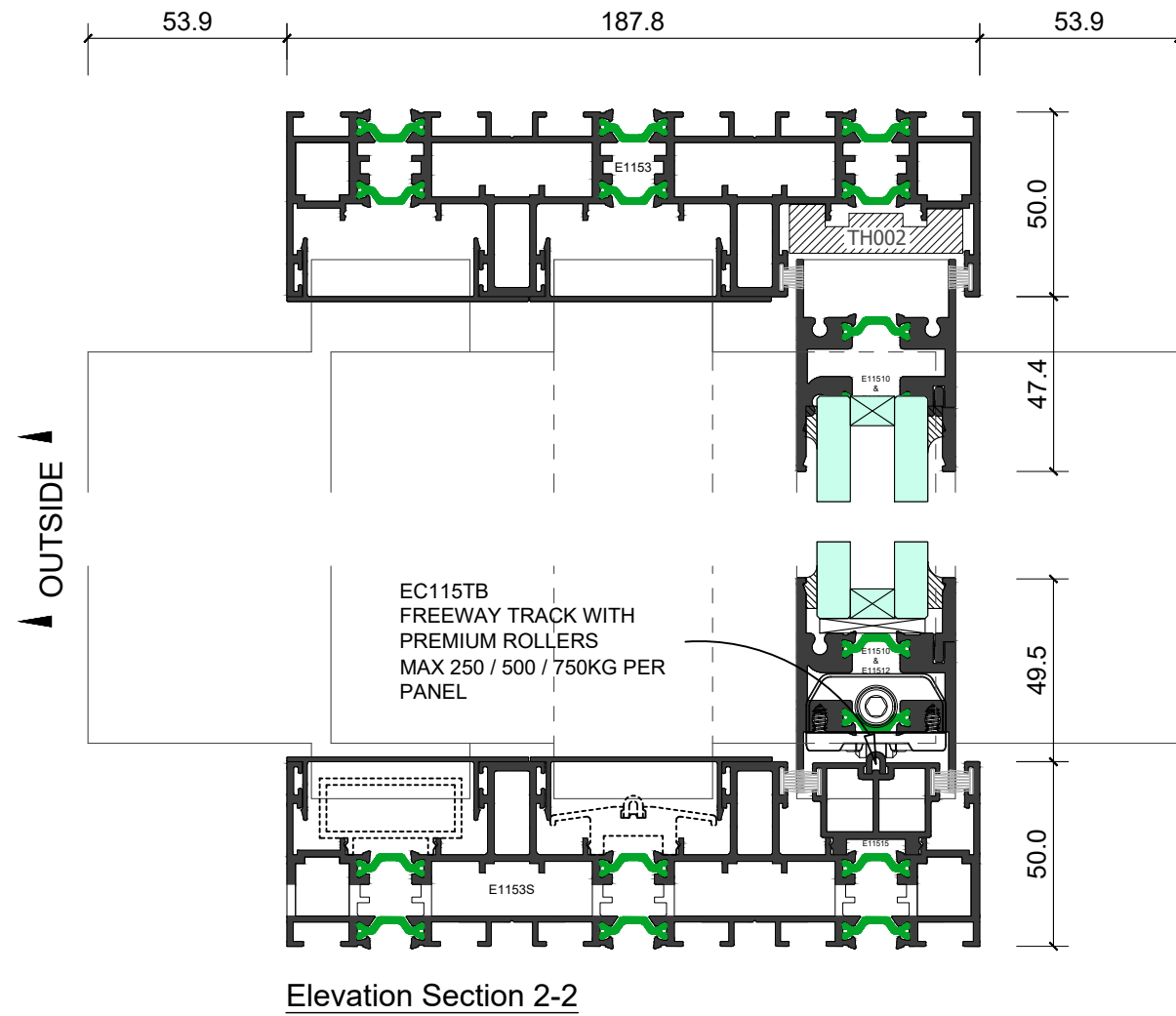

Plan Section 1-1

EC 115TB

Layouts

SLIDING DOOR

4 TRACKS

THERMECO™

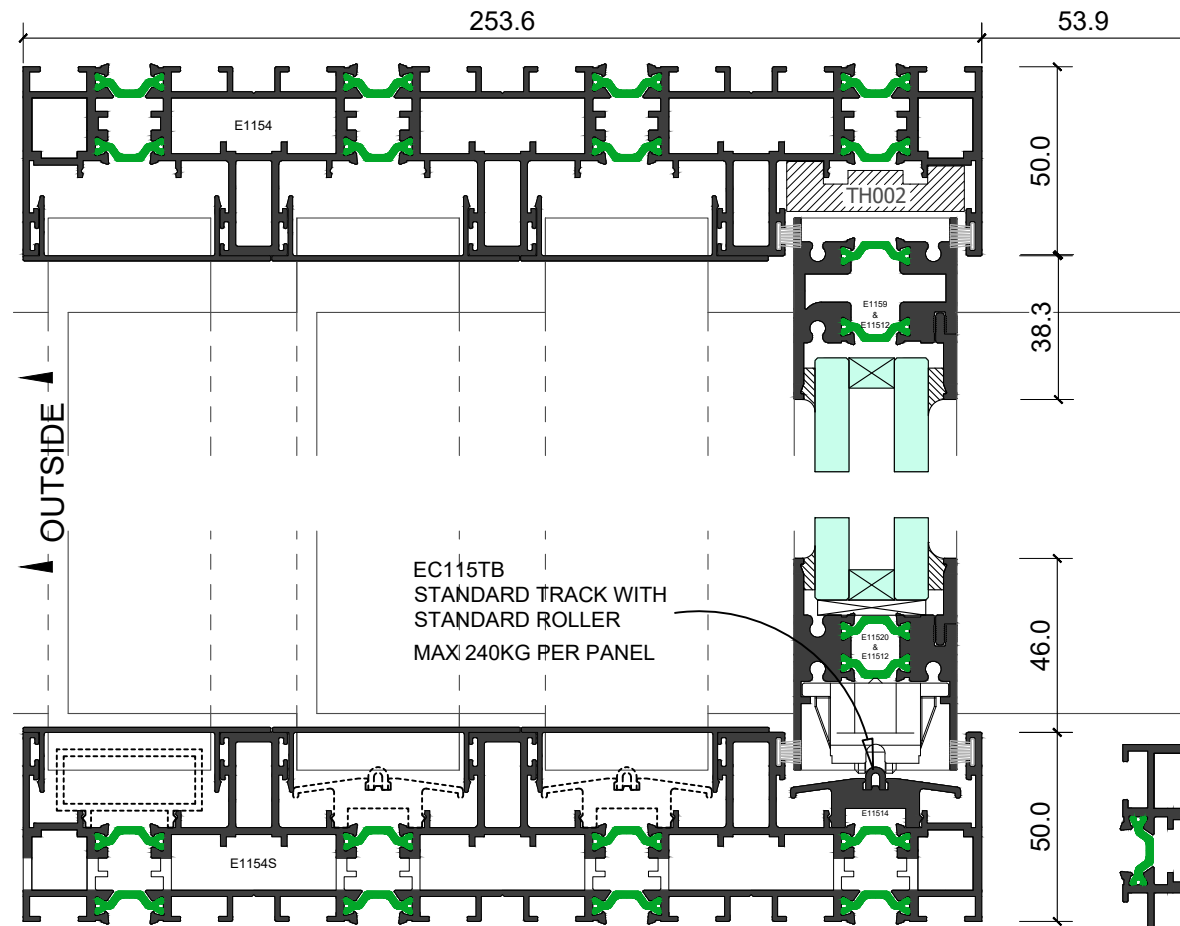

Elevation Section 2-2

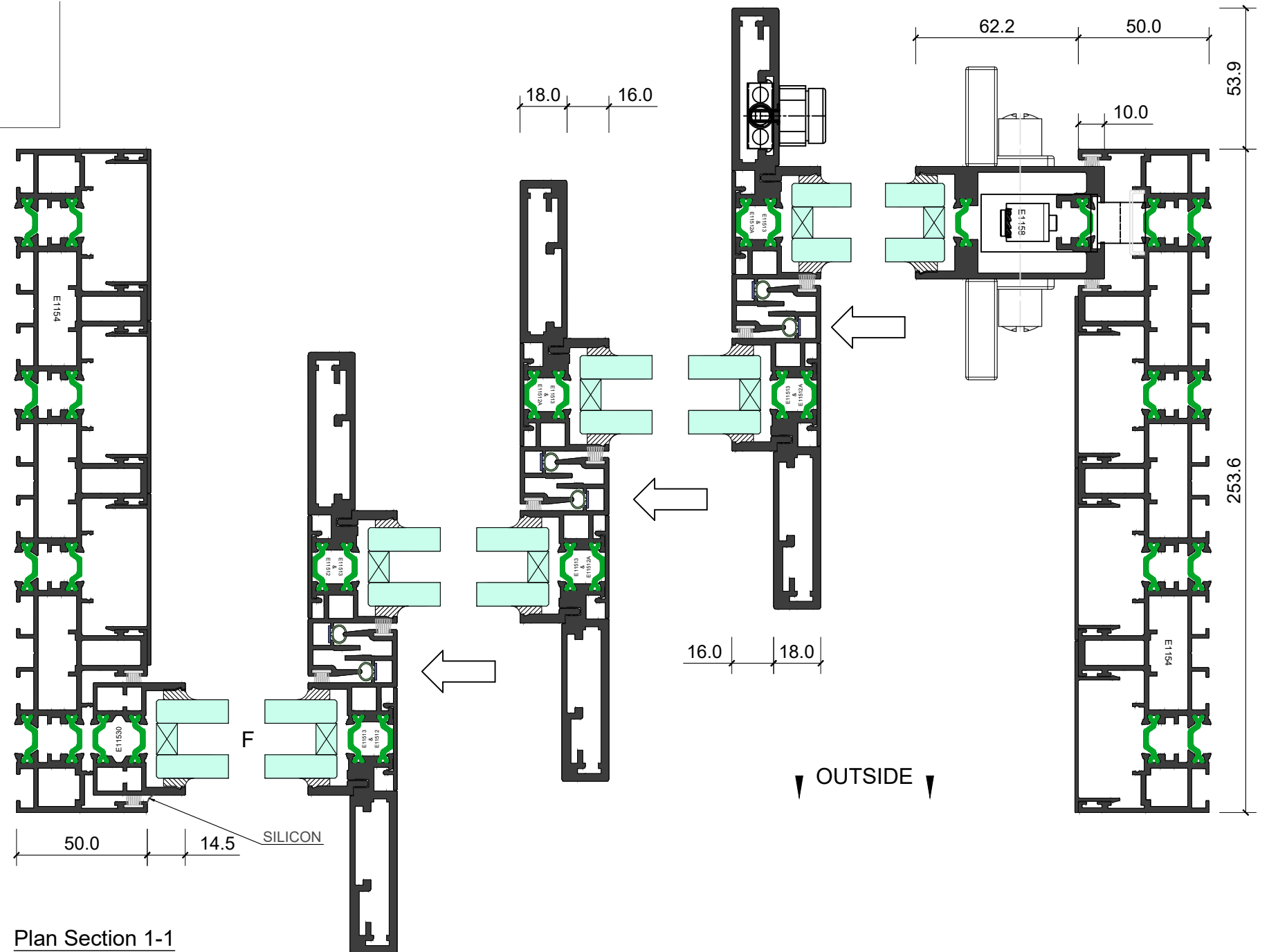

Plan Section 1-1

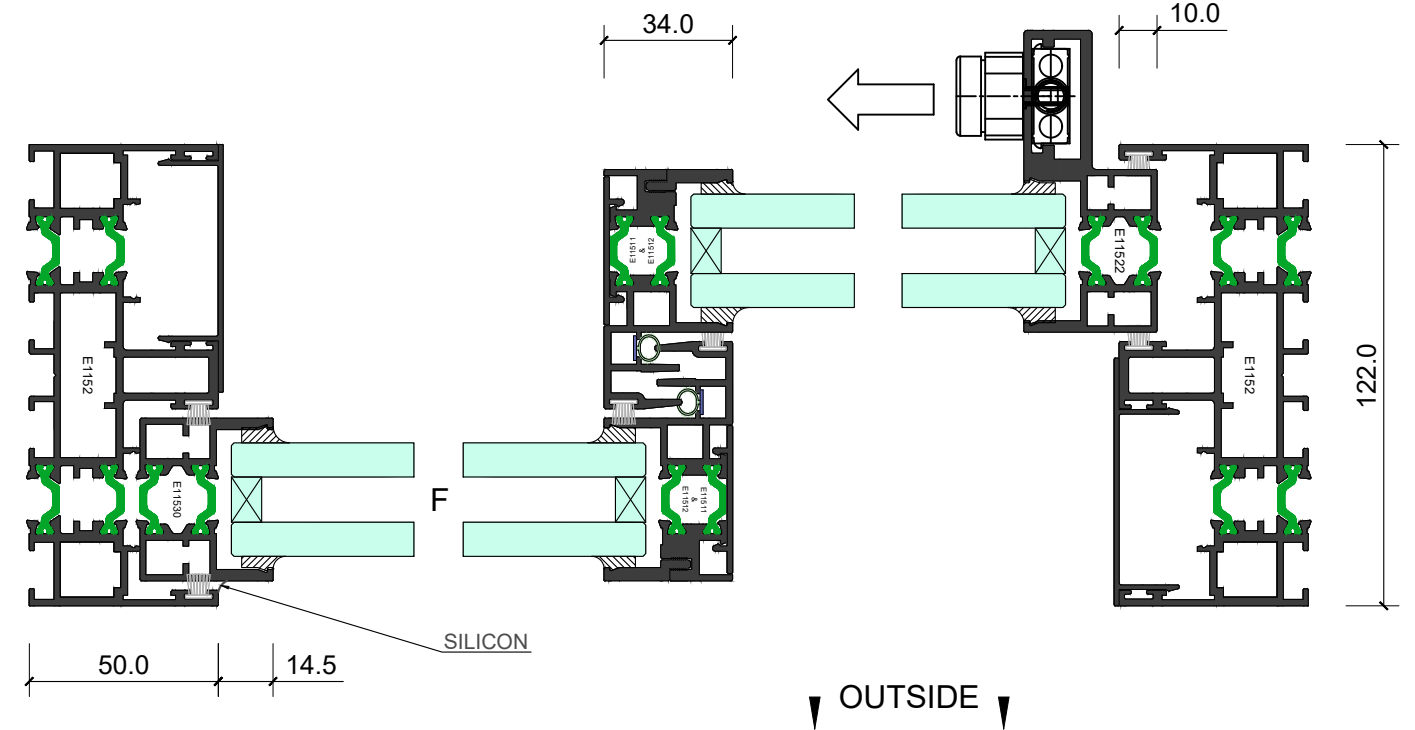
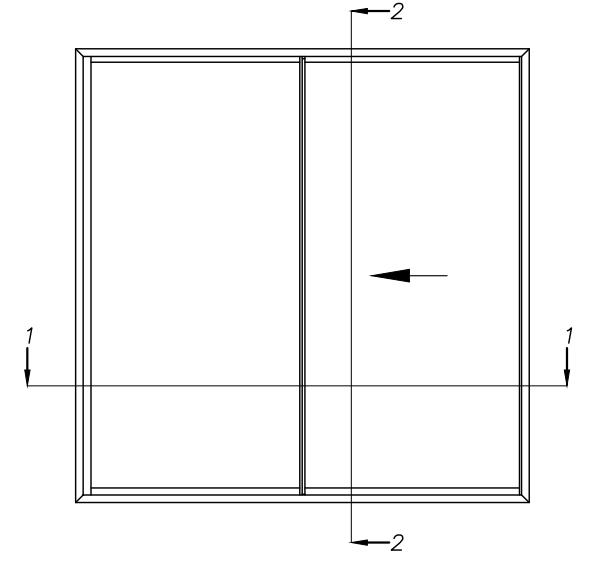
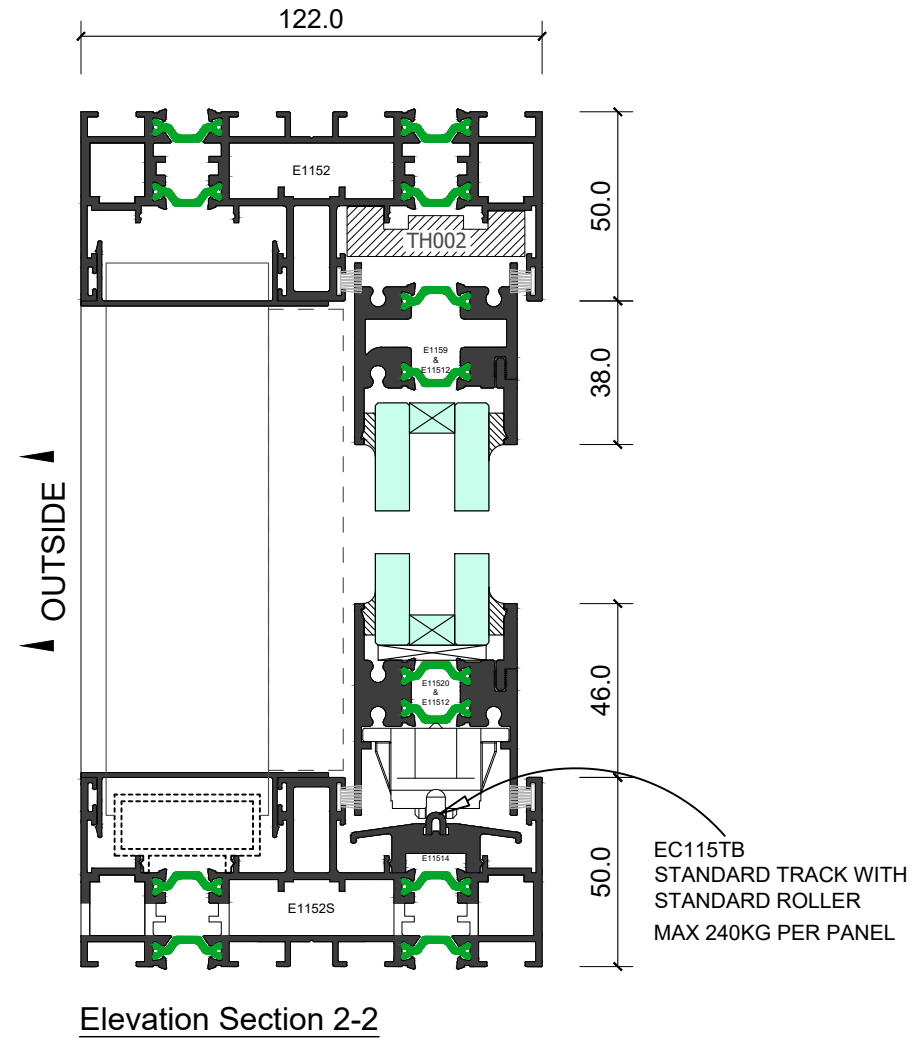

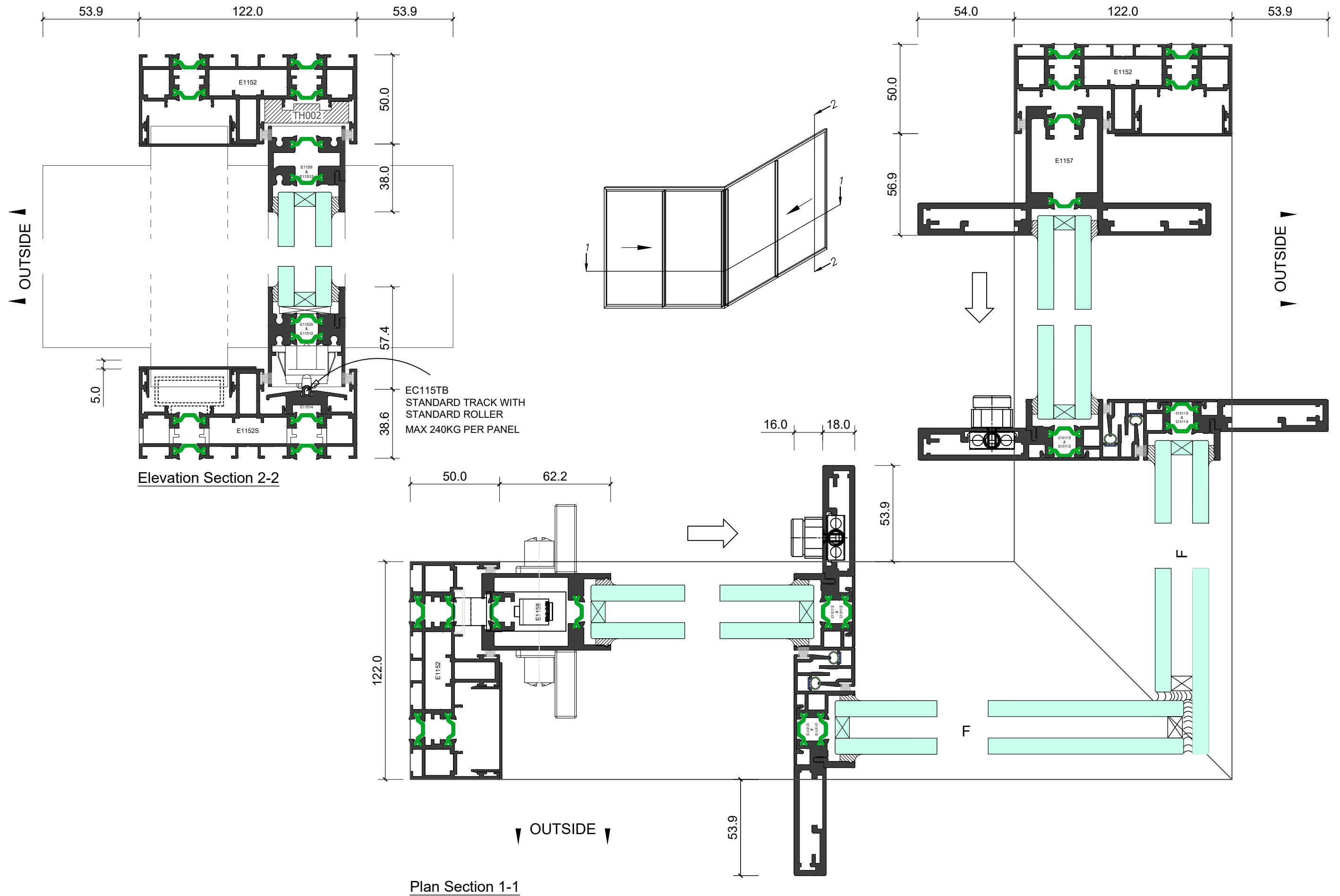

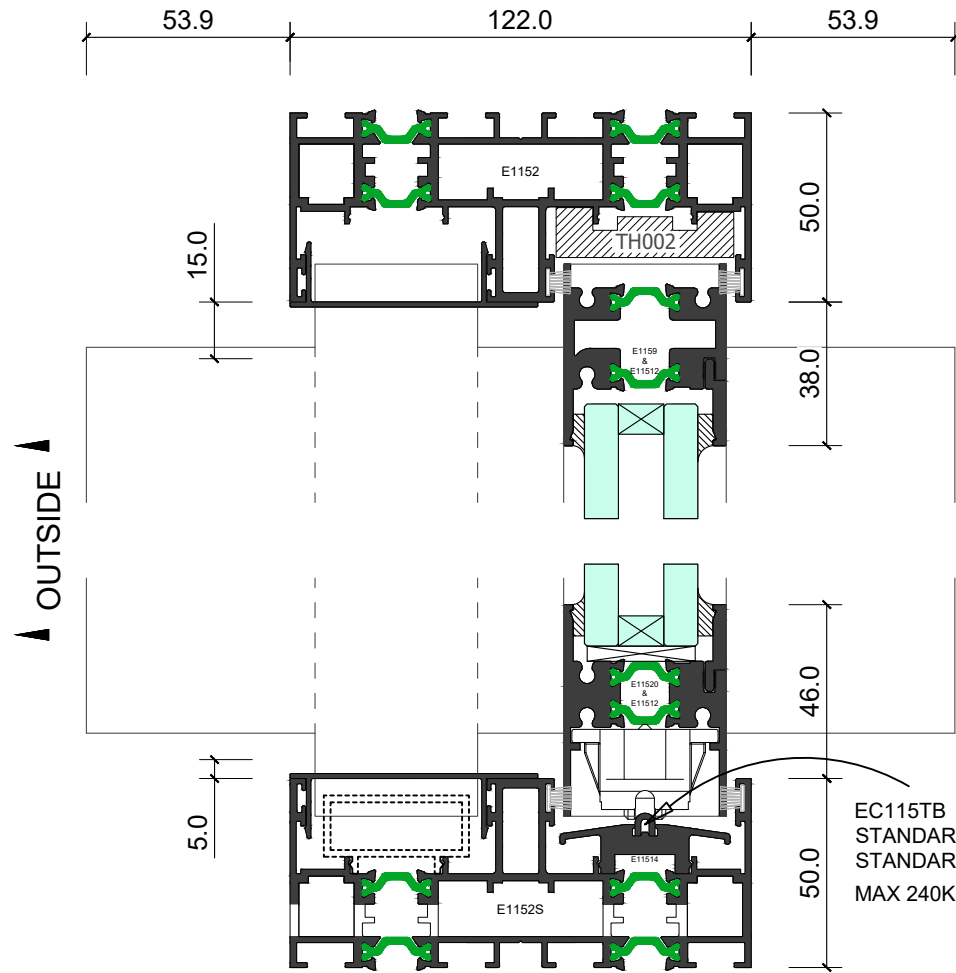

Elevation Section 2-2

EC115TB
STANDARD TRACK WITH
STANDARD ROLLER
MAX 240KG PER PANEL

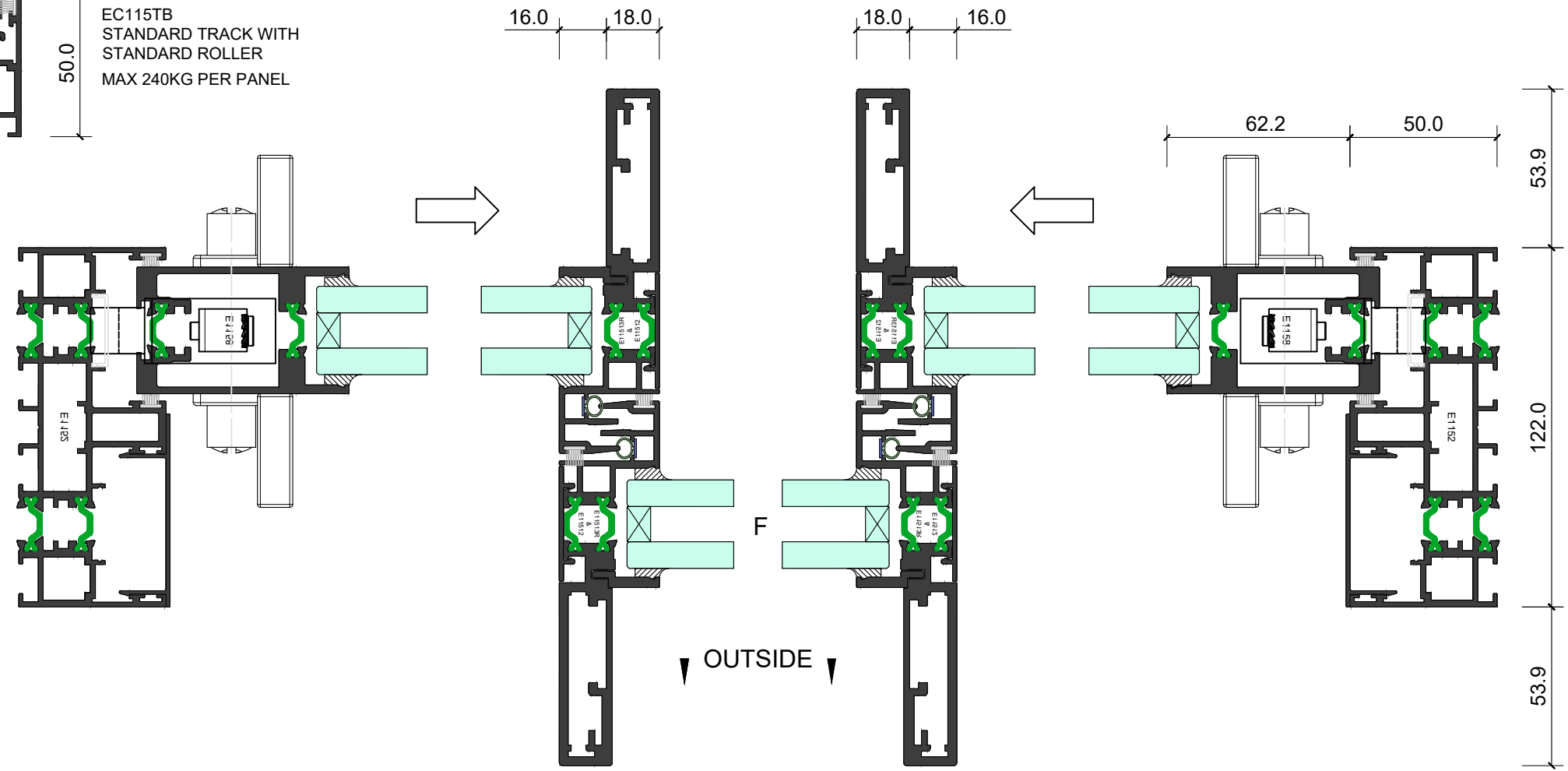
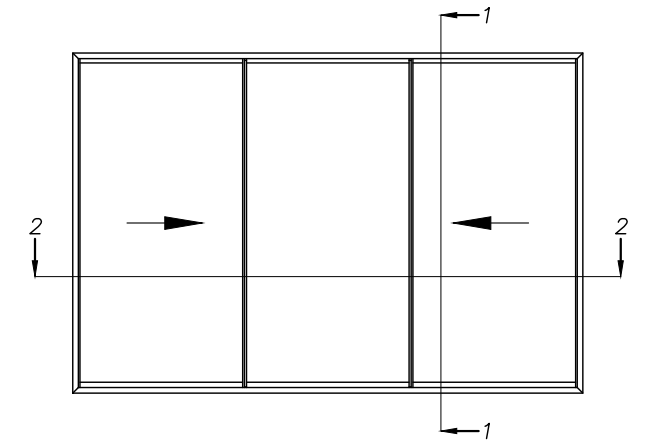

Plan Section 1-1

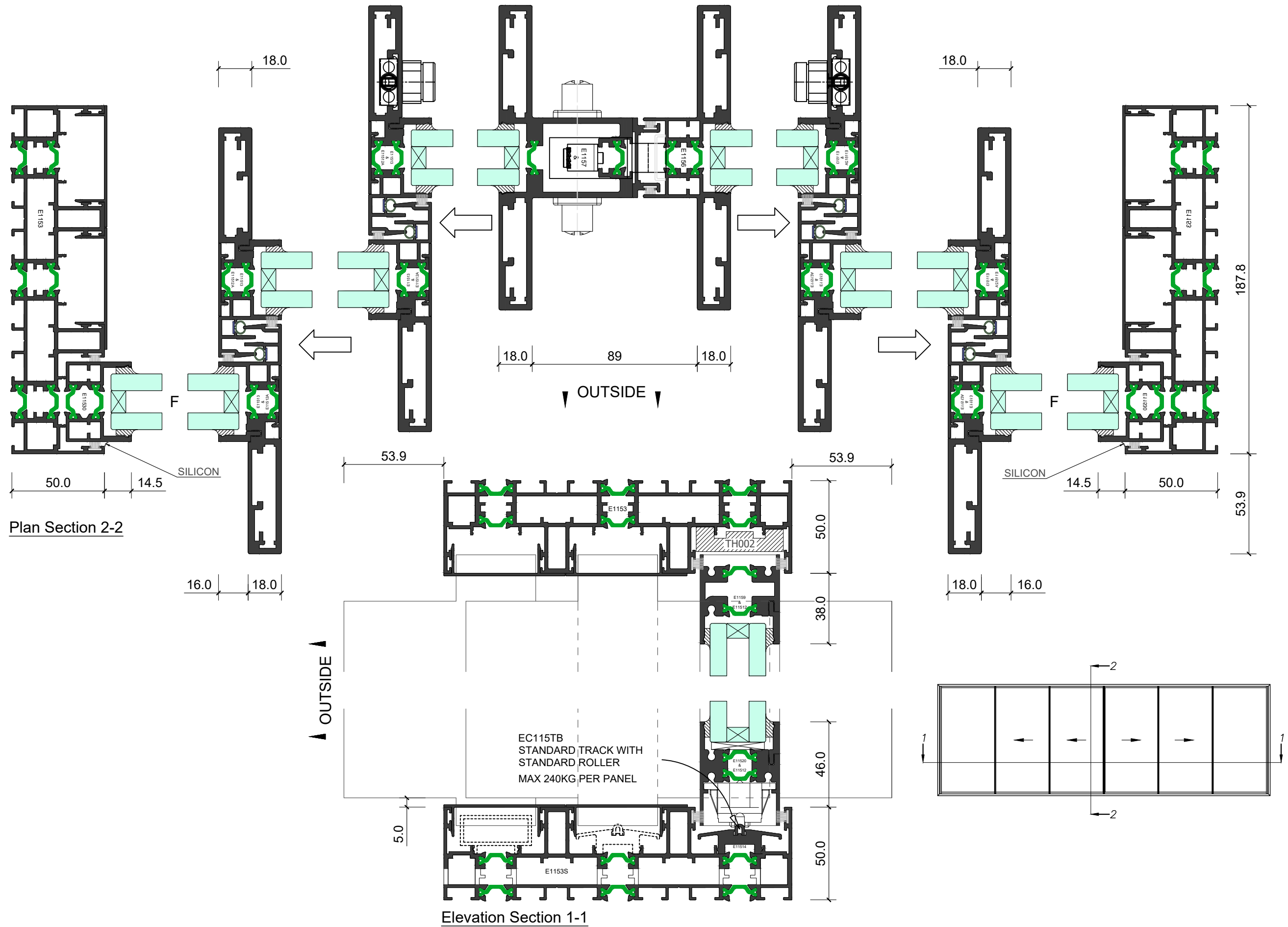

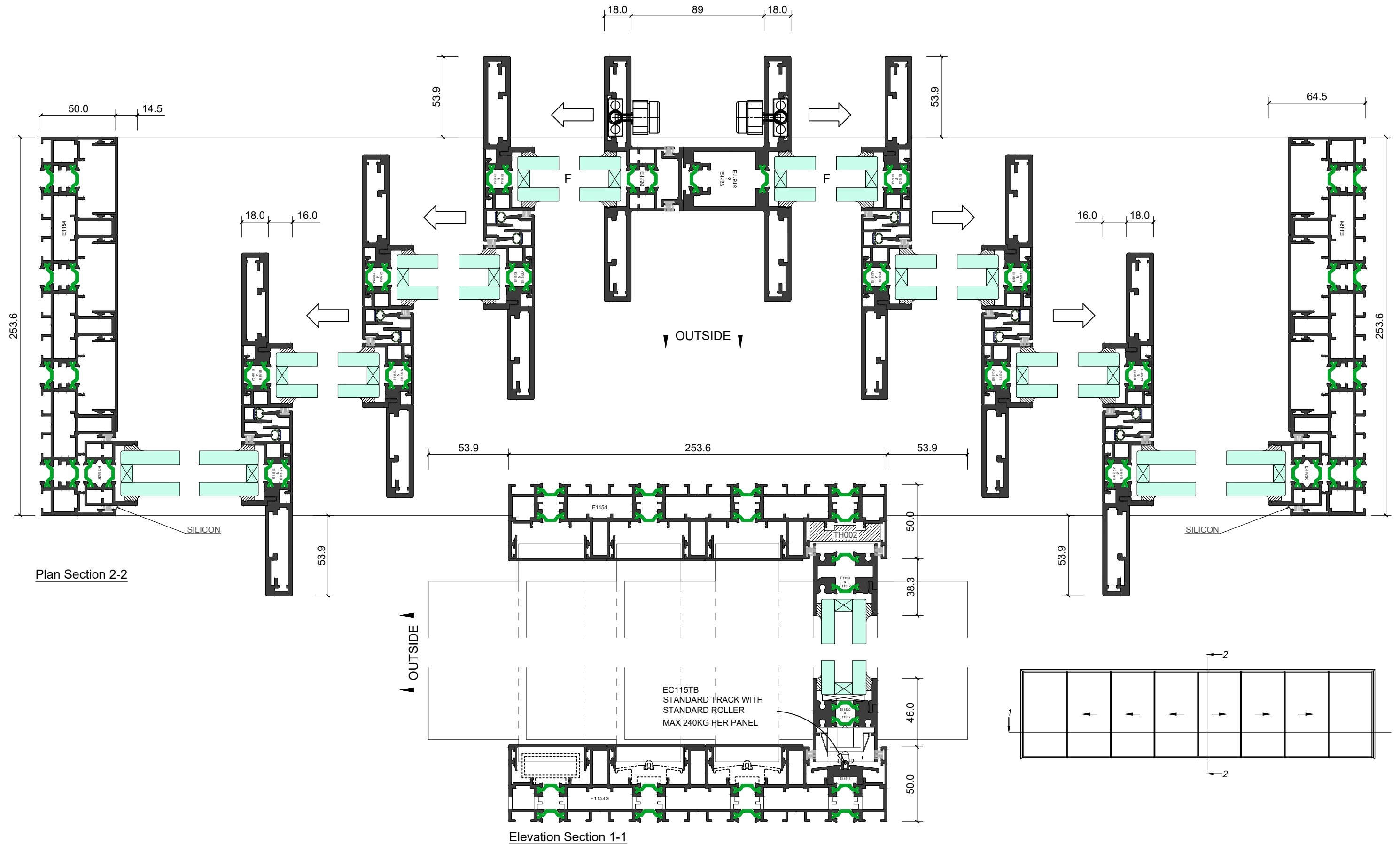

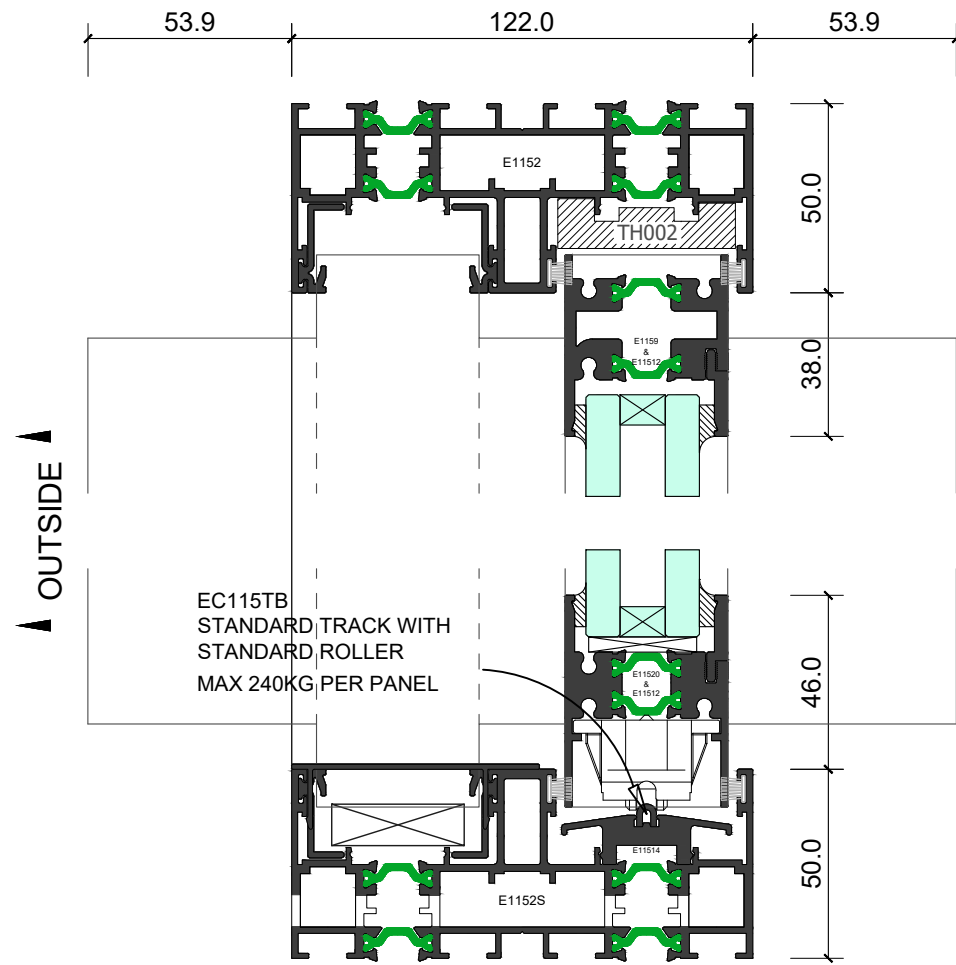

Elevation Section 2-2

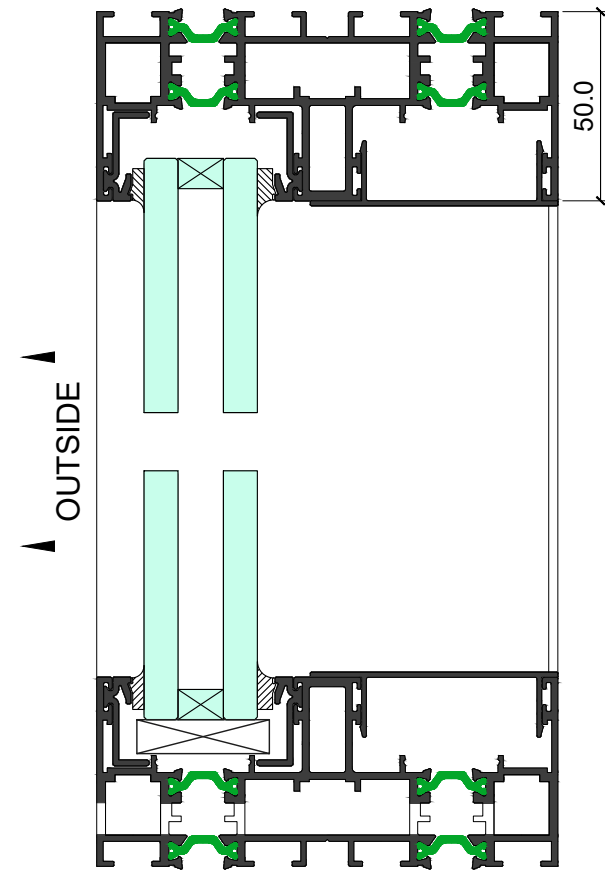

Elevation Section 3-3

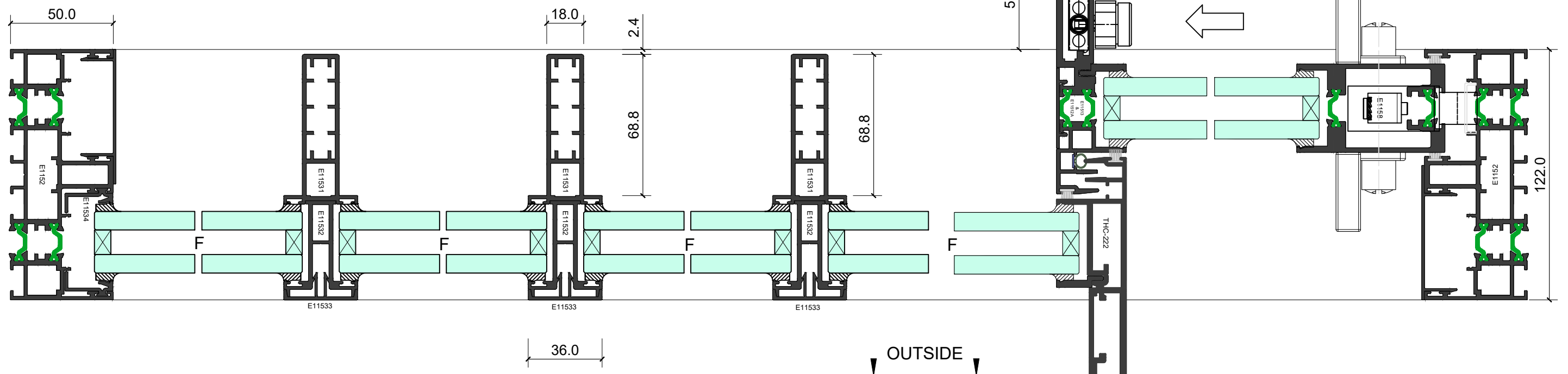
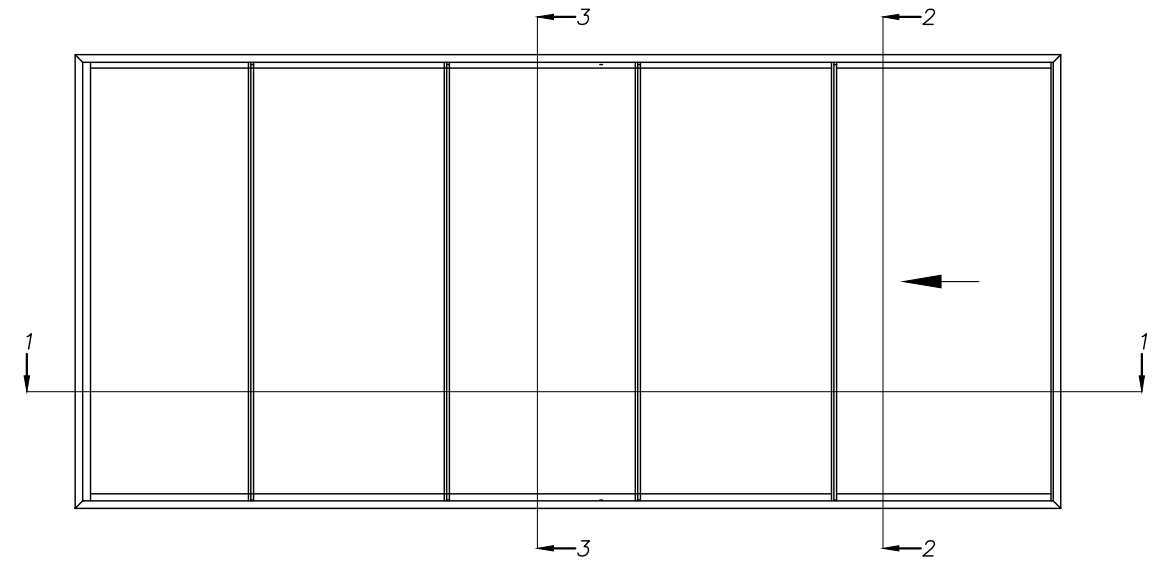

Plan Section 1-1

Layouts

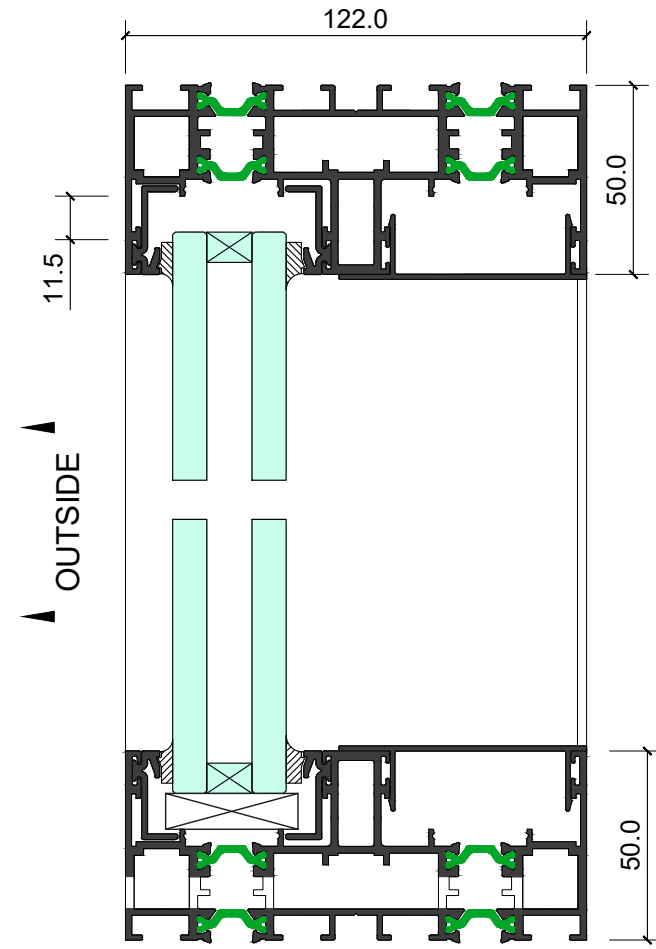

Elevation Section 2-2

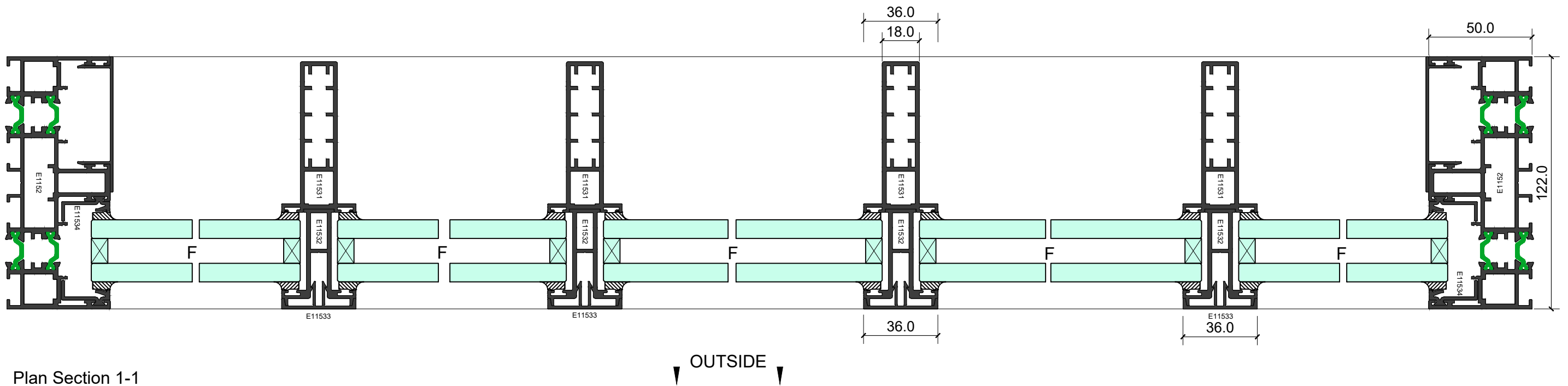
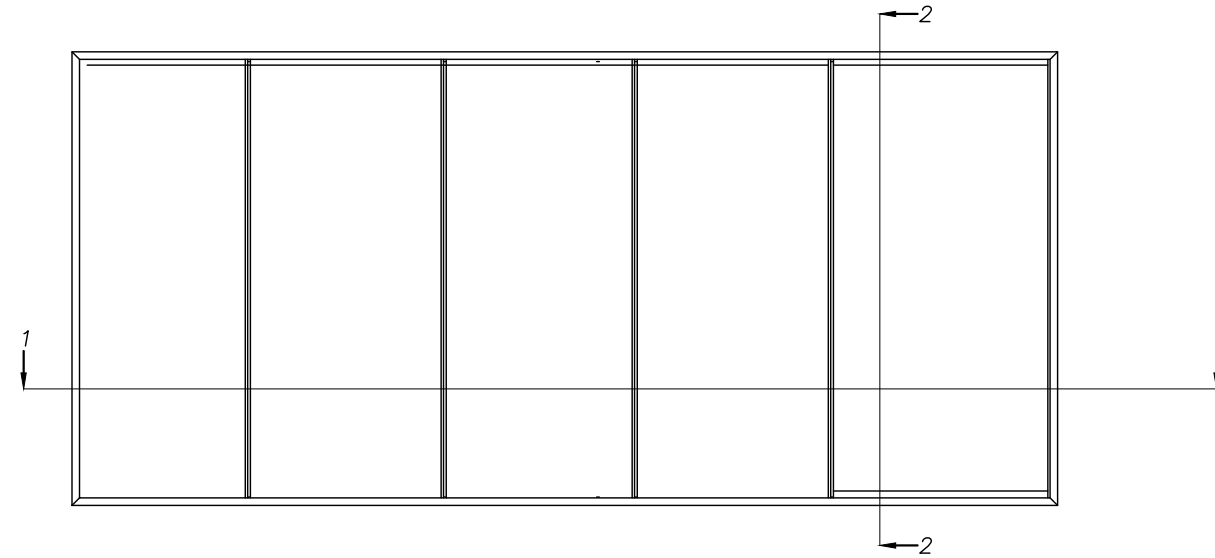

Plan Section 1-1

