

EC55TB

Layouts

BI-FOLD
(OPEN OUT)

THERMECO™

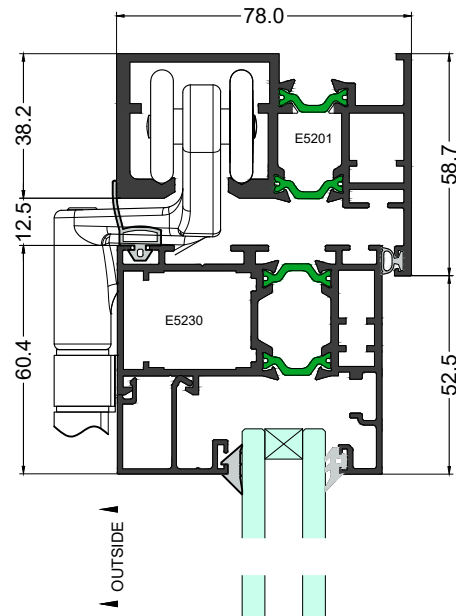

Elevation Section 1-1

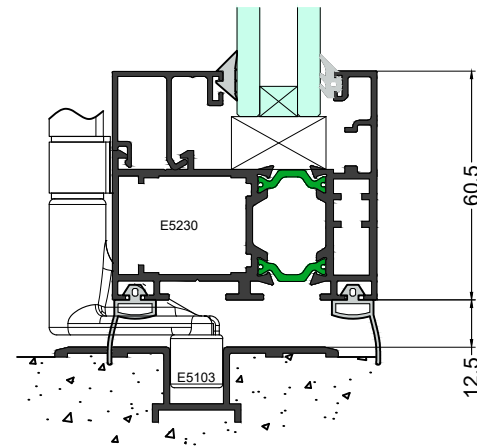
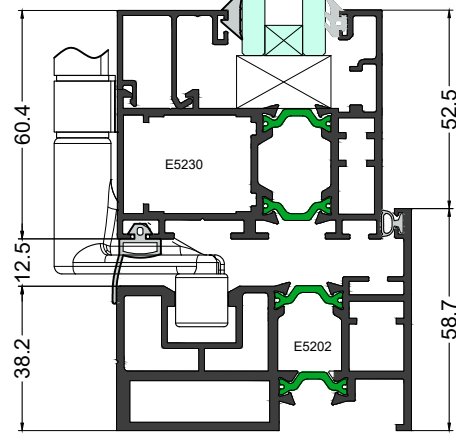

Alternative Sill

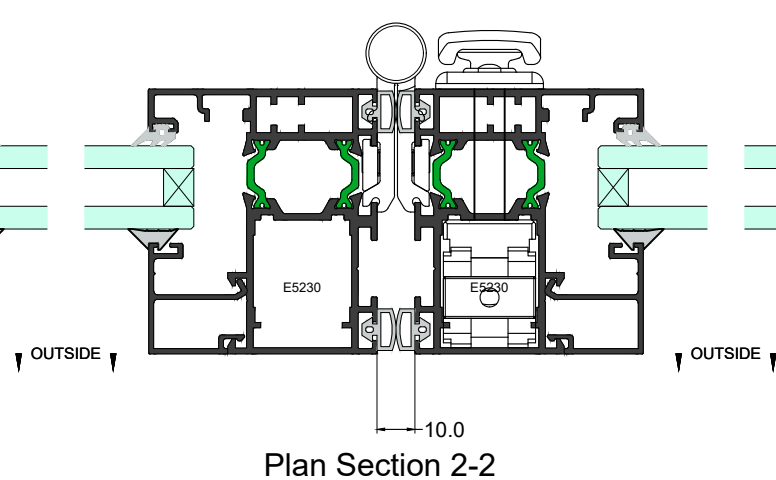
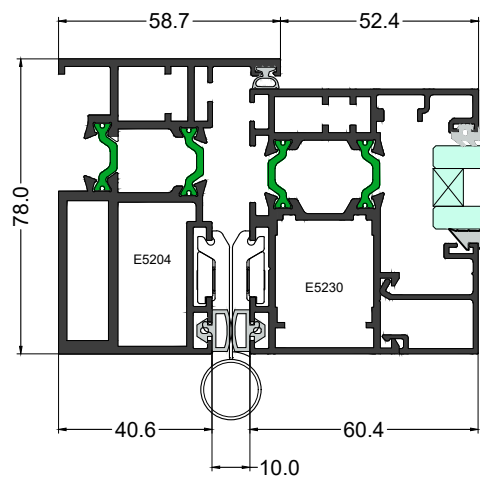
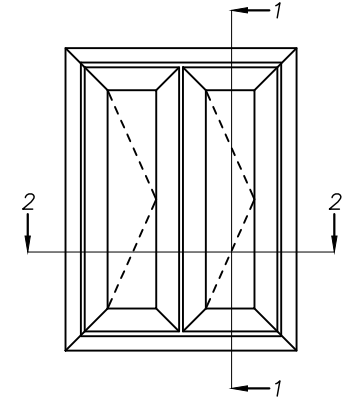

Plan Section 2-2

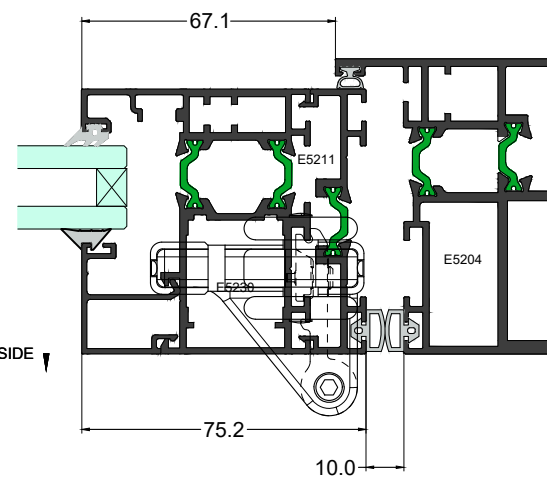

EC55TB

Layouts

BI-FOLD

(OPEN IN)

THERMECO™

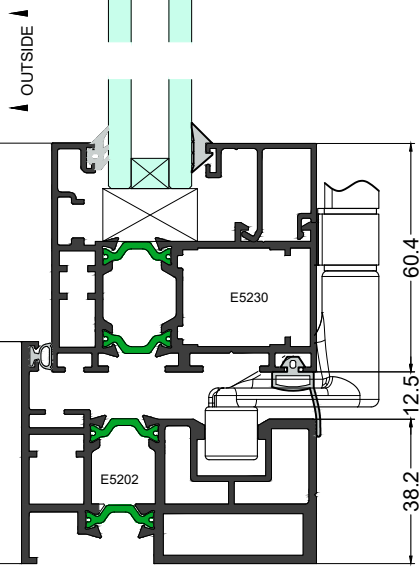
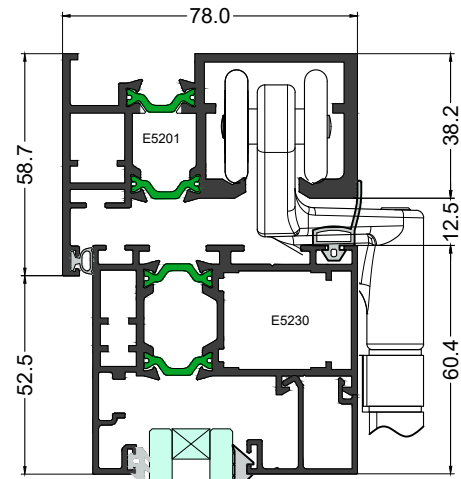

Elevation Section 1-1

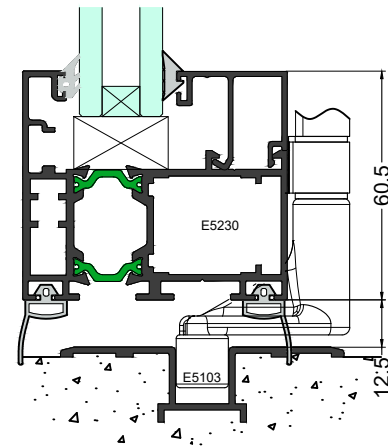

Alternative Sill

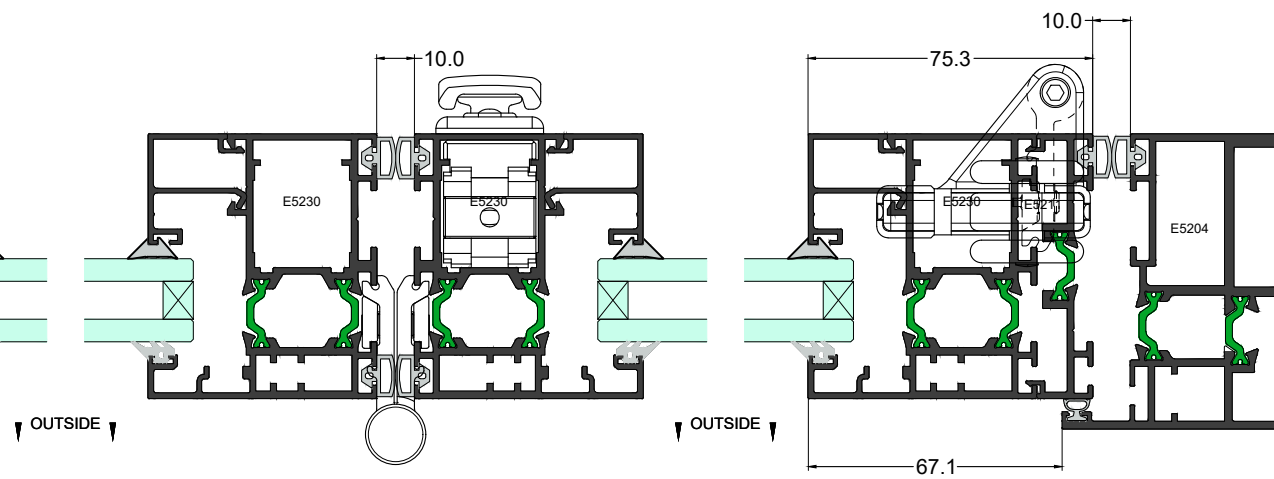
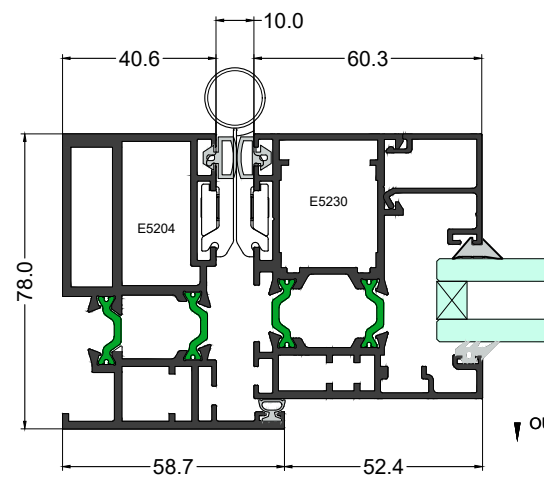

Plan Section 2-2

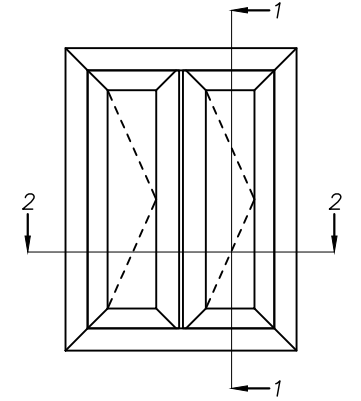

EC55TB

Layouts

BI-FOLD
(OPEN OUT)

THERMECO™

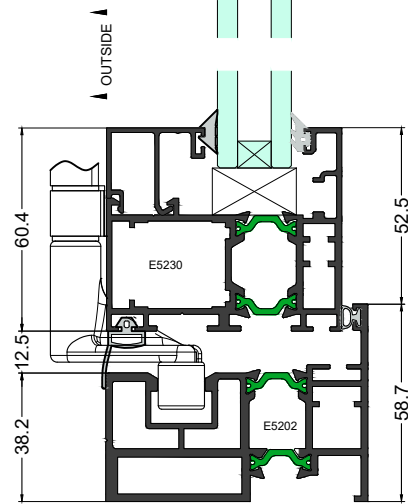
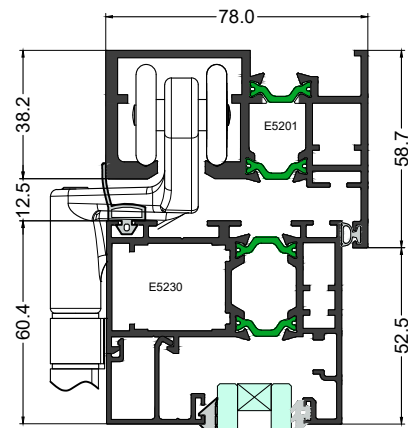

Elevation Section 1-1

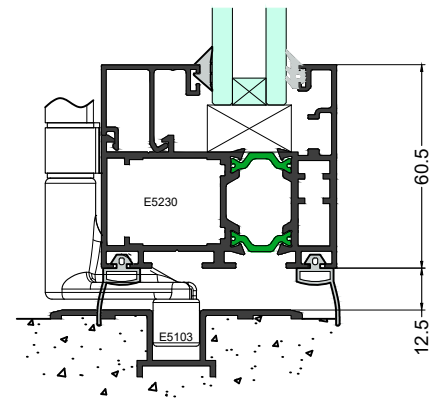

Alternative Sill

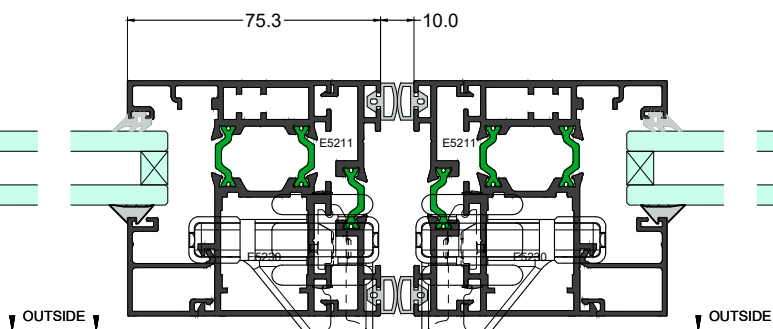
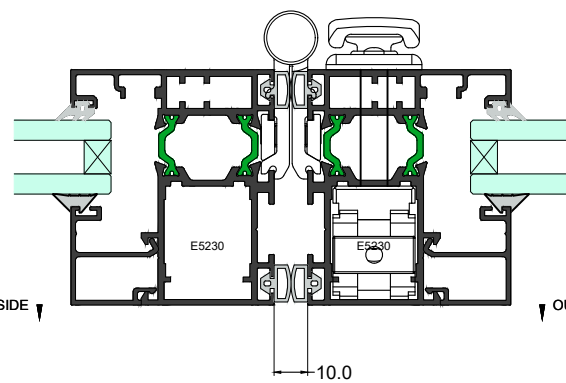
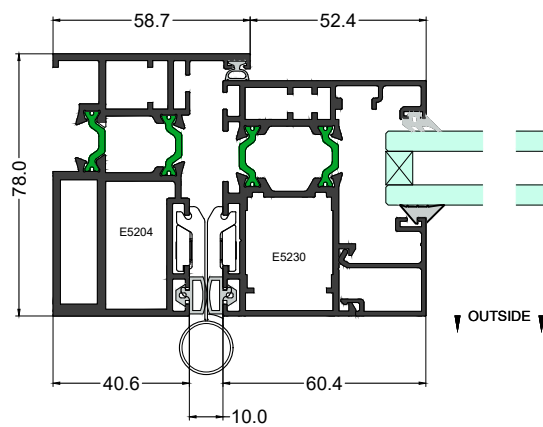
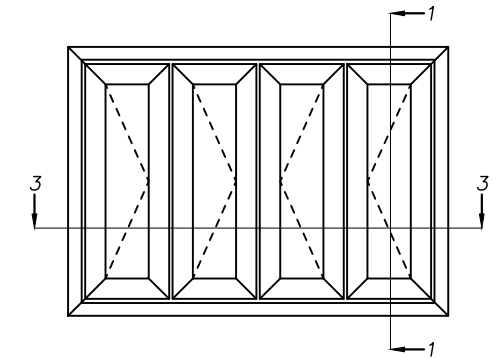

Plan Section 3-3

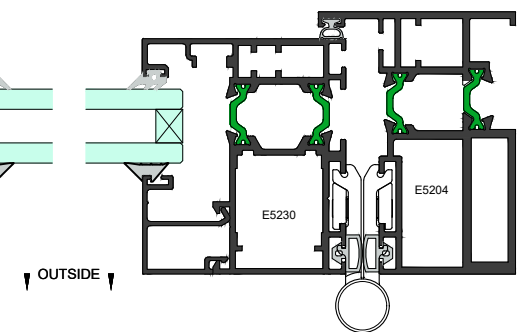
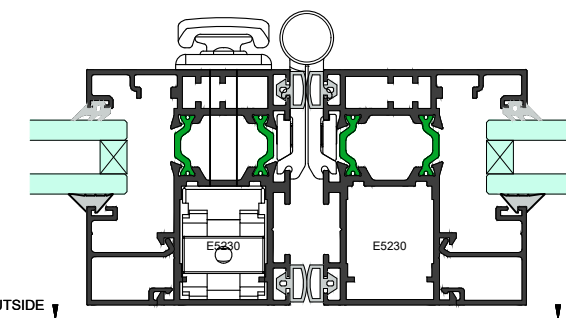

EC55TB

Layouts

BI-FOLD

(OPEN IN)

THERMECO™

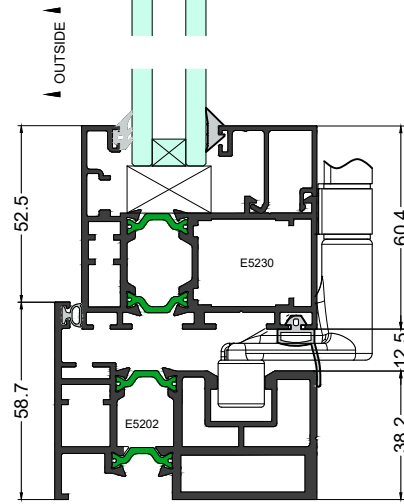
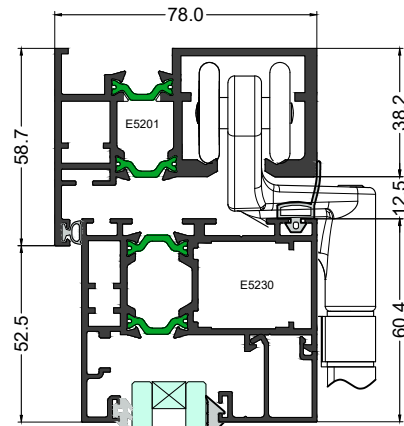

Elevation Section 1-1

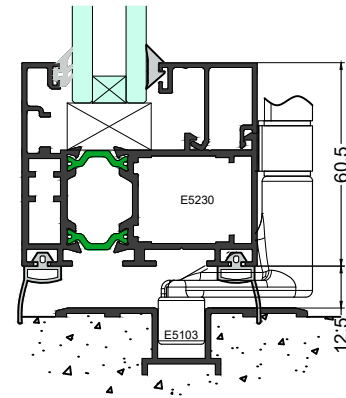

Alternative Sill

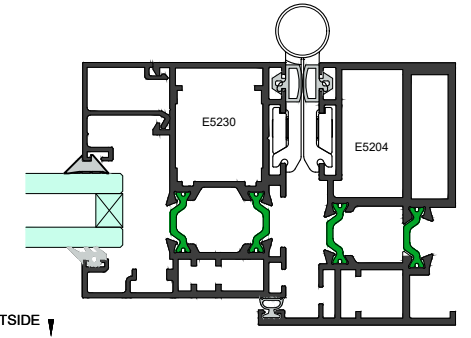
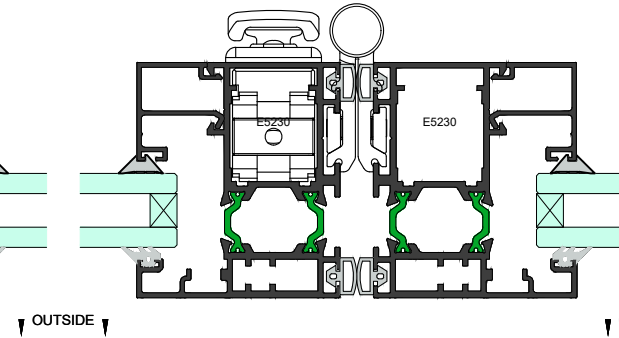
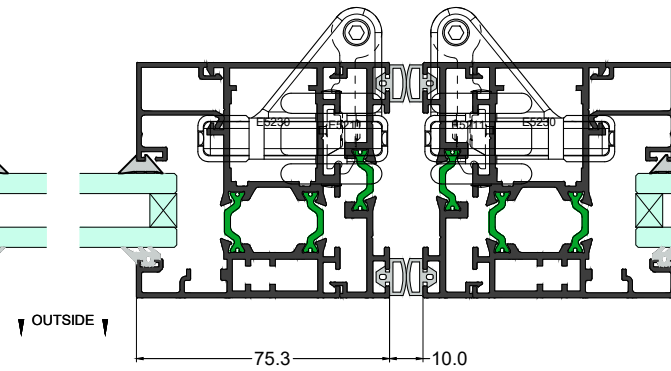
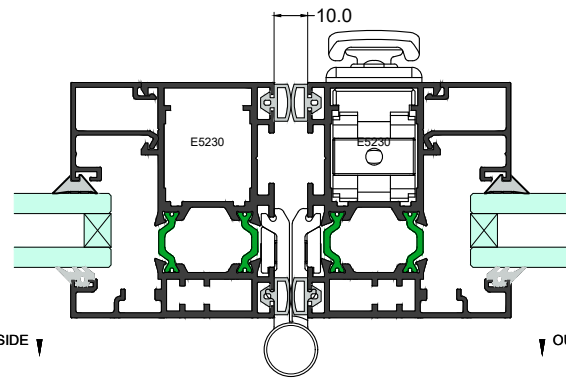
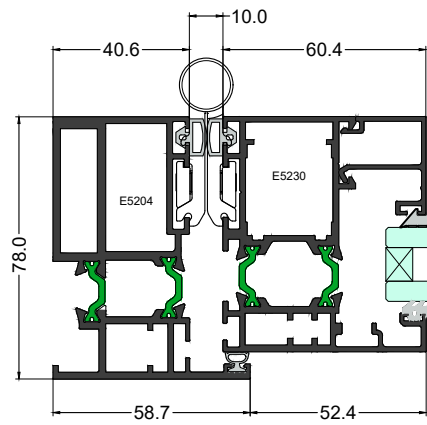
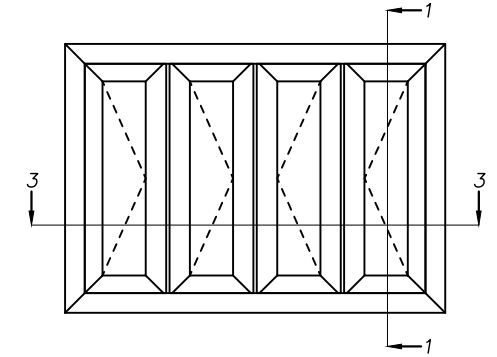

Plan Section 3-3

EC55TB

Layouts

BI-FOLD
(OPEN OUT)

THERMECO™

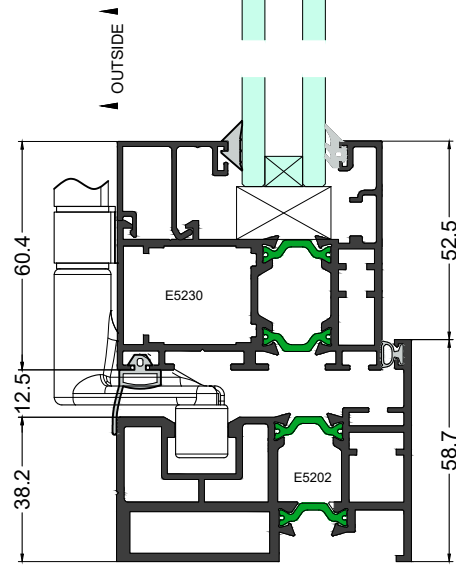
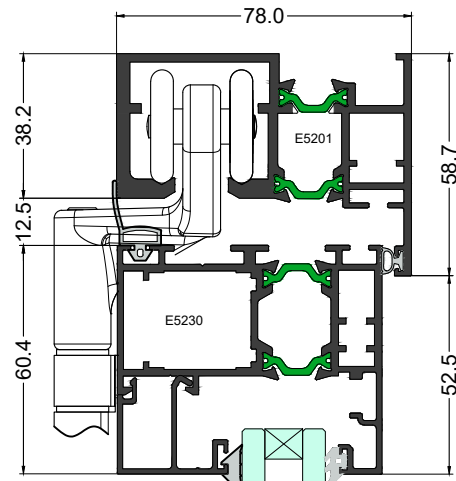

Elevation Section 1-1

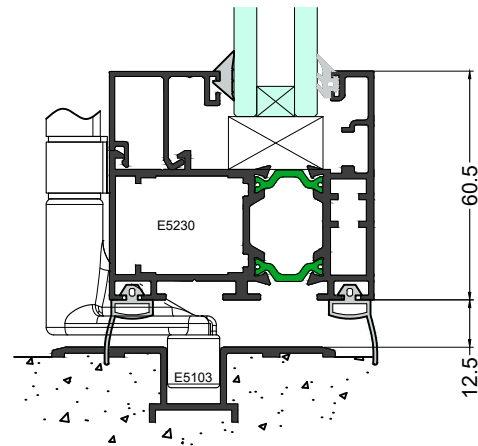

Alternative Sill

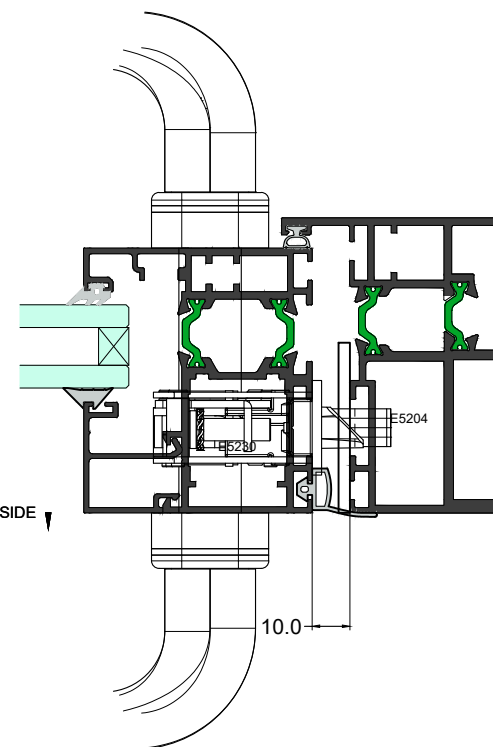
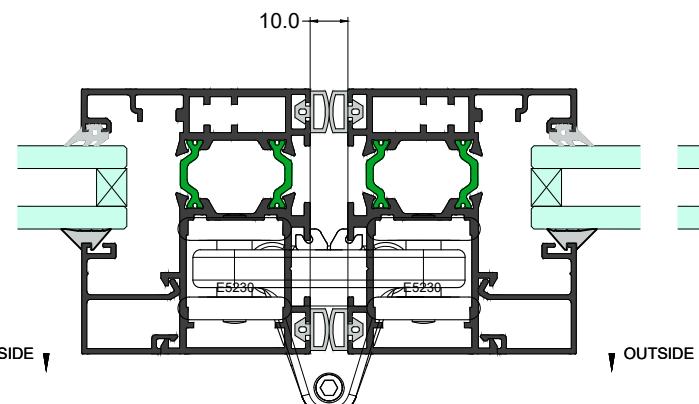
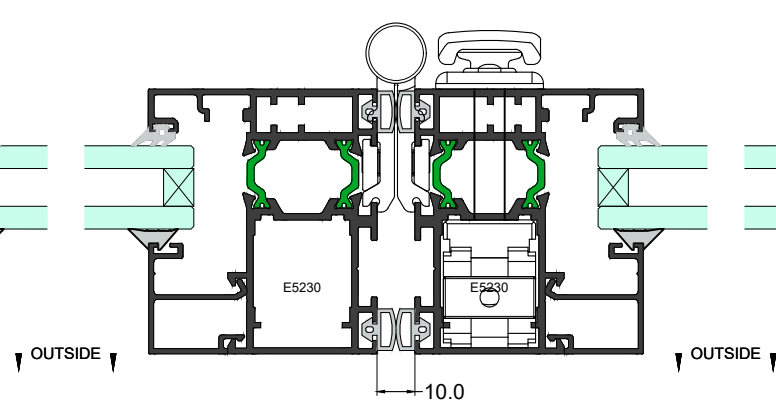
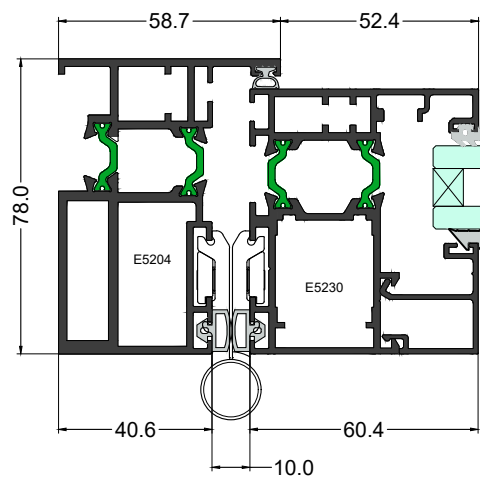
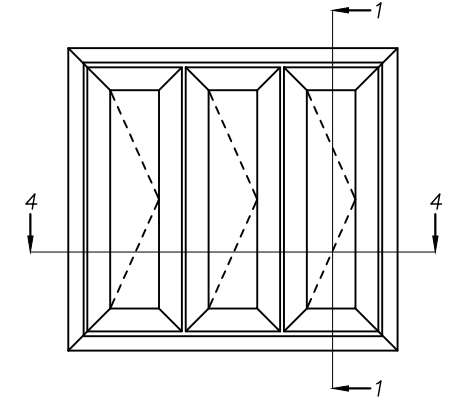

Plan Section 4-4

EC55TB

Layouts

BI-FOLD

(OPEN IN)

THERMECO™

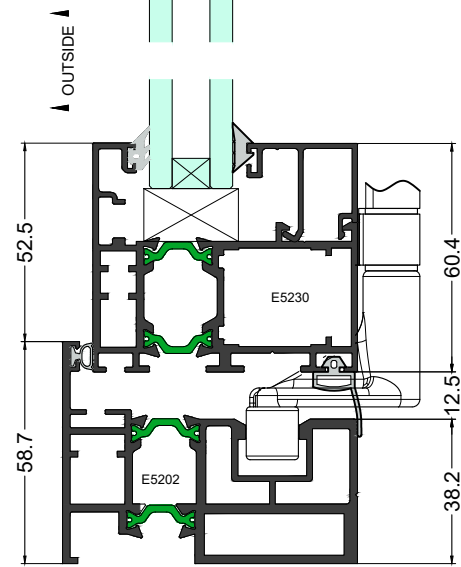
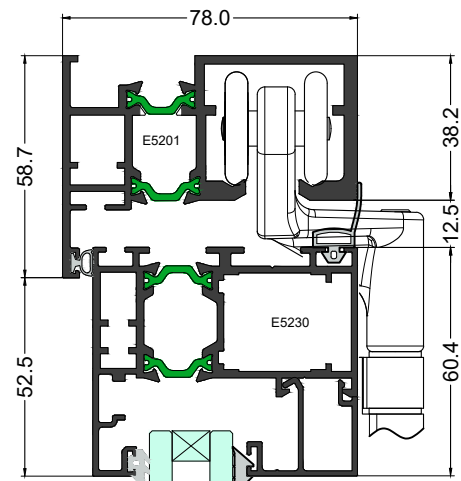

Elevation Section 1-1

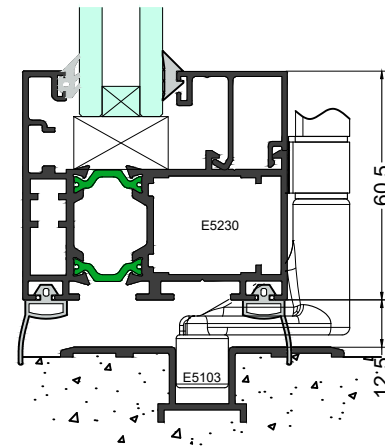

Alternative Sill

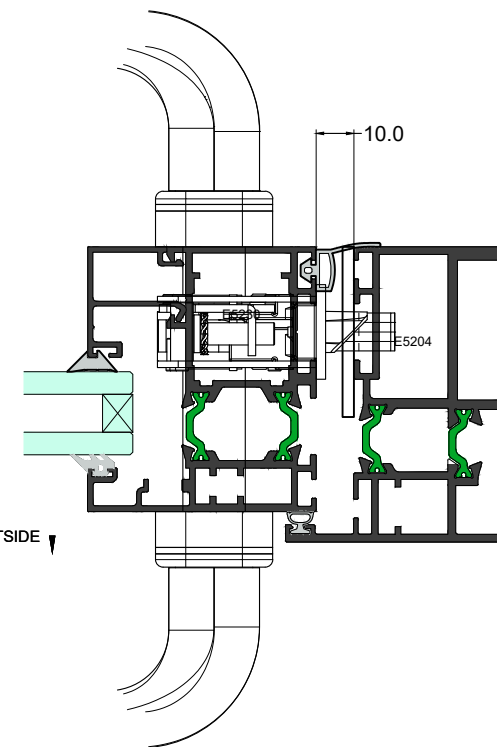
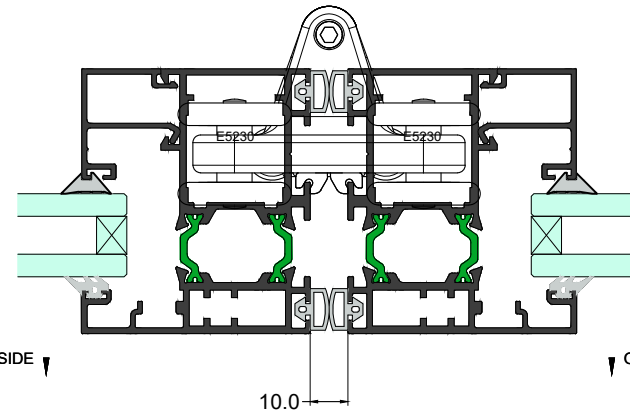
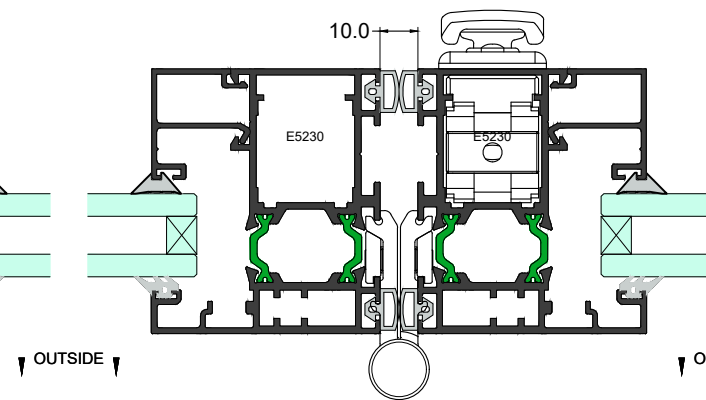
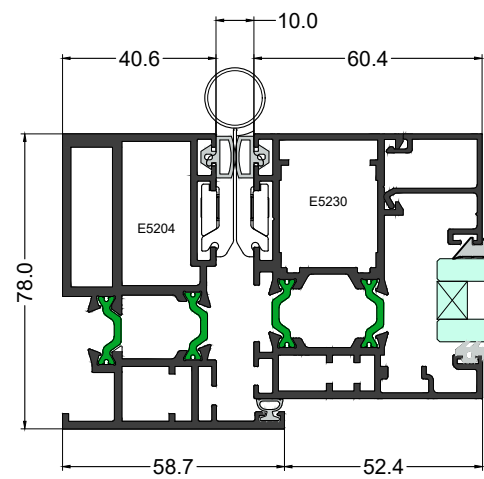
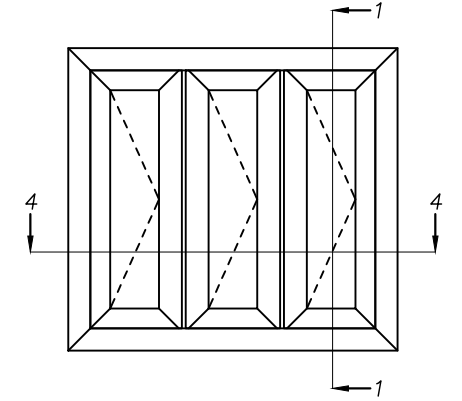

Plan Section 4-4

EC55TB

Layouts

BI-FOLD
(OPEN OUT)

THERMECO™

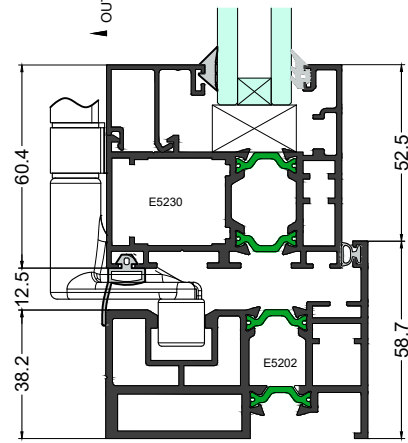
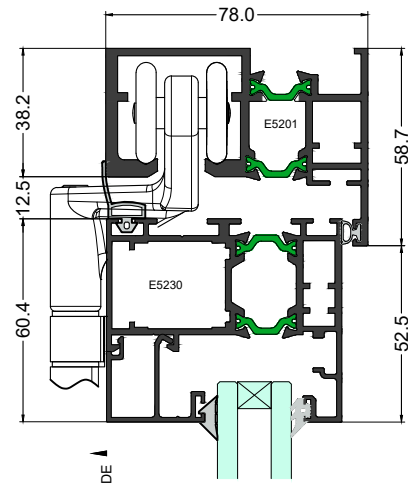

Elevation Section 1-1

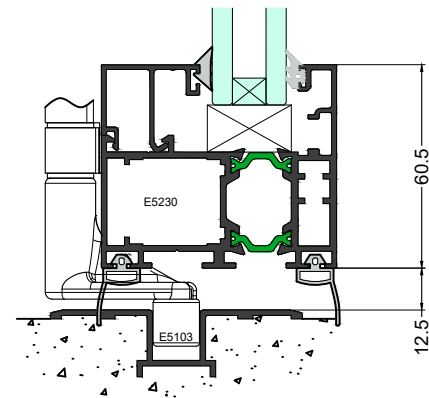

Alternative Sill

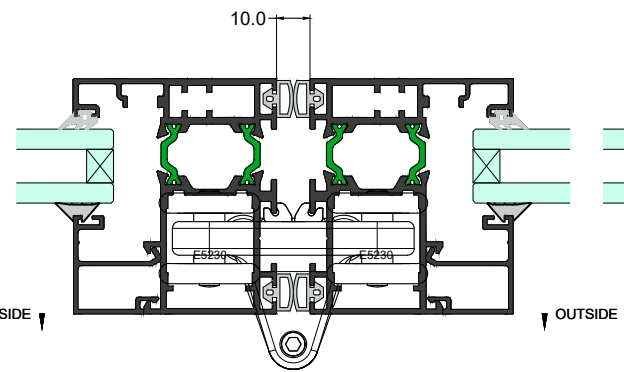
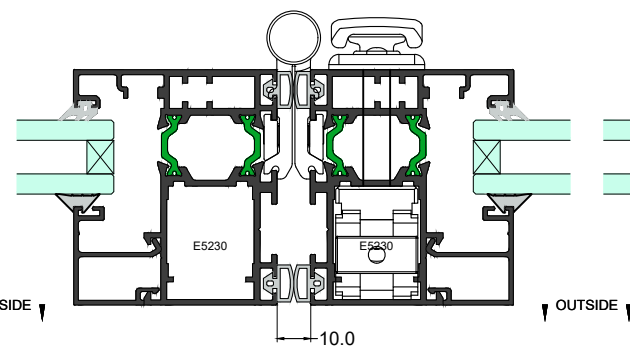
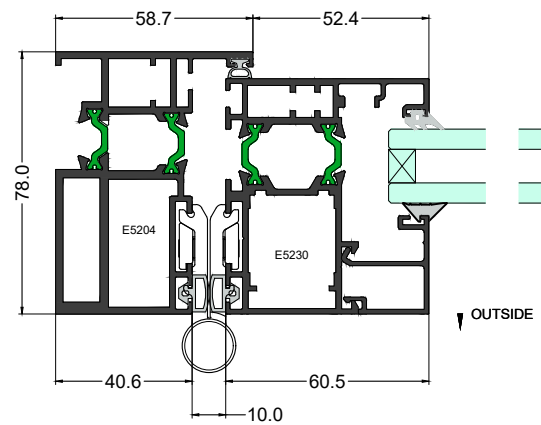
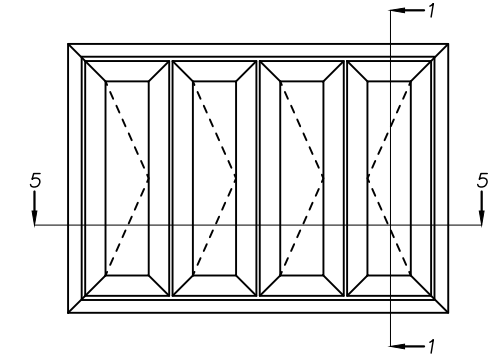

Plan Section 5-5

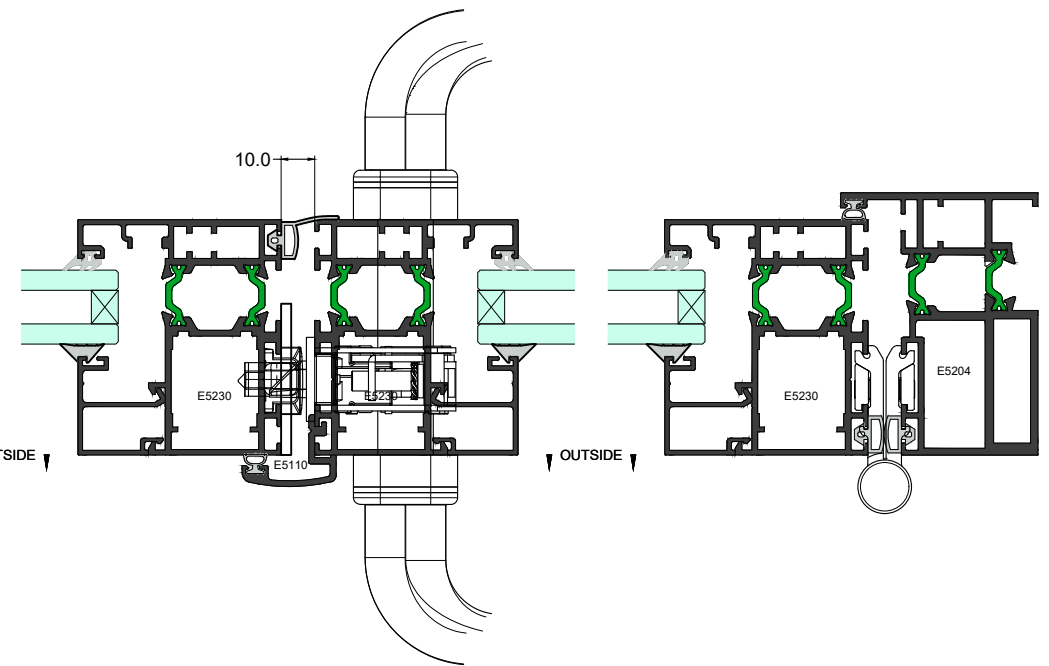

EC55TB

Layouts

BI-FOLD

(OPEN IN)

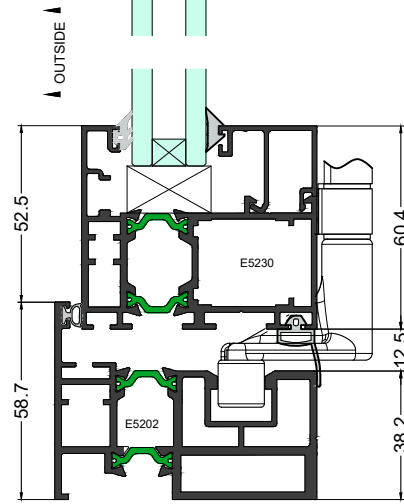
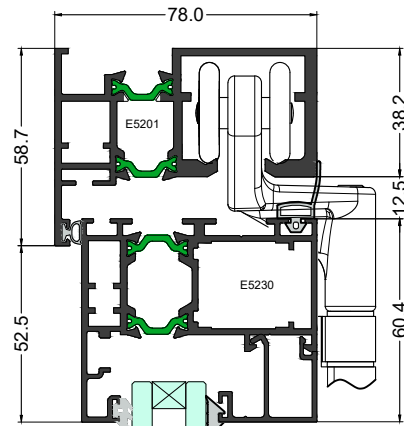

Elevation Section 1-1

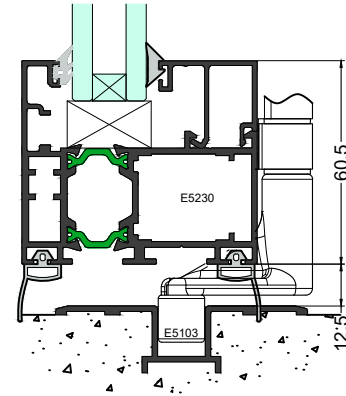

Alternative Sill

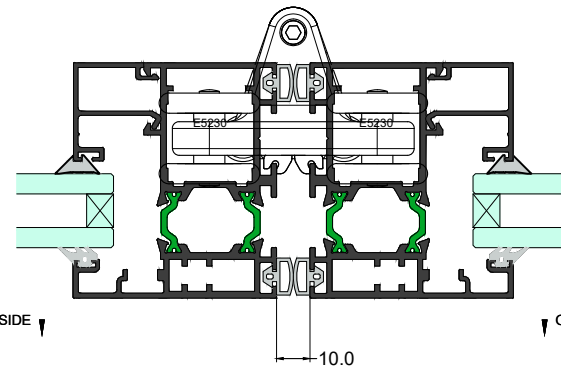
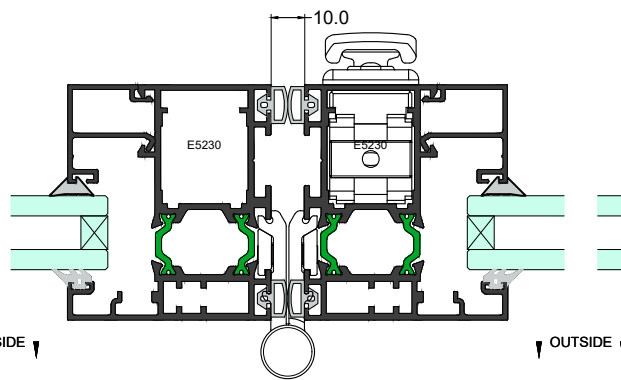
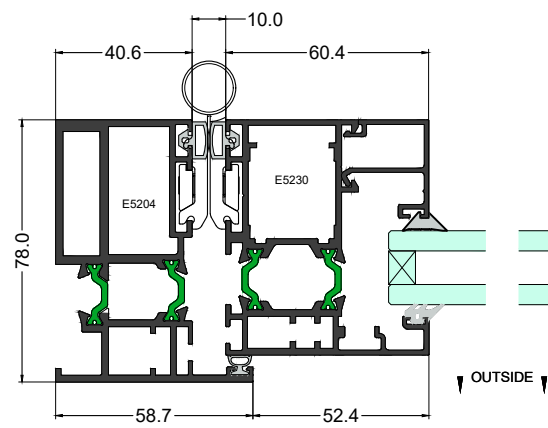
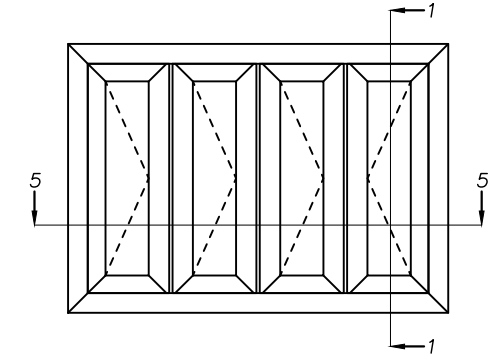

Plan Section 5-5

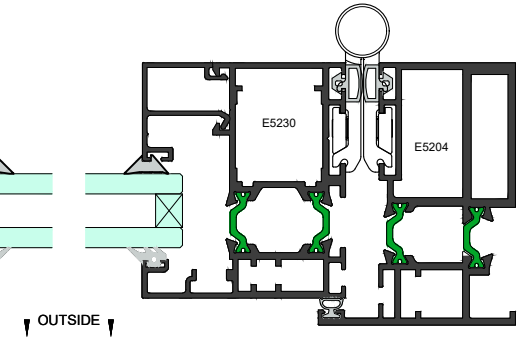
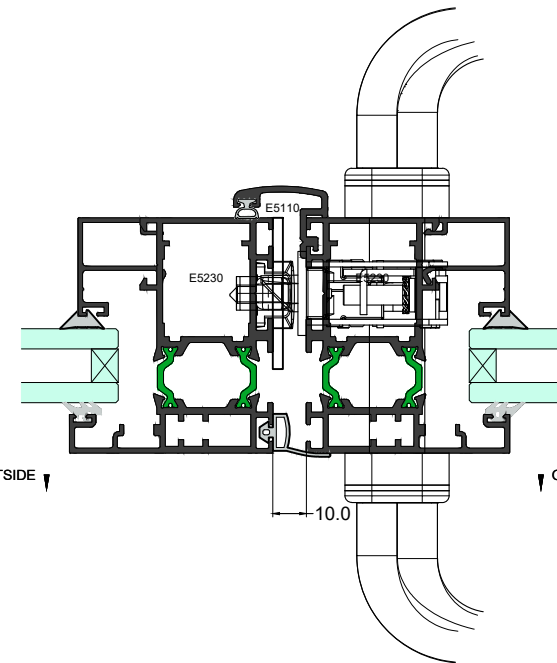

EC55TB

Layouts

BI-FOLD
(OPEN OUT)

THERMECO™

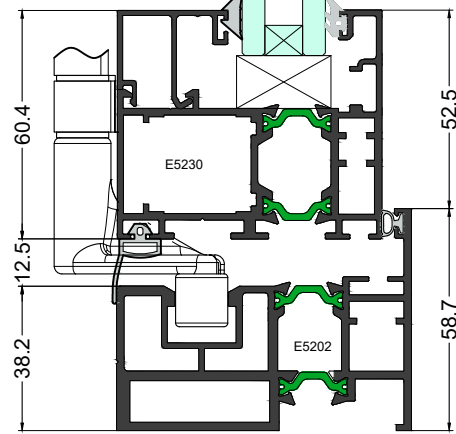
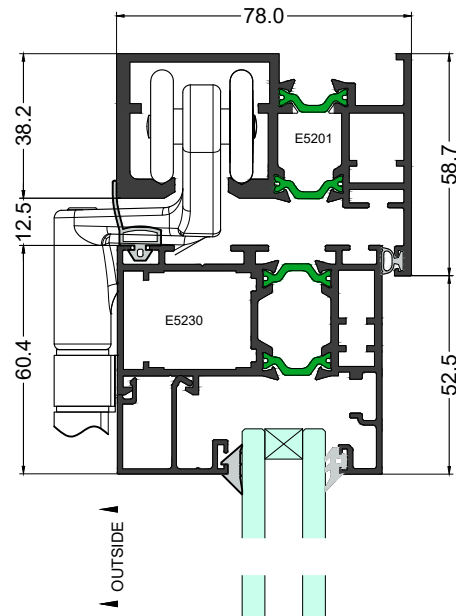

Elevation Section 1-1

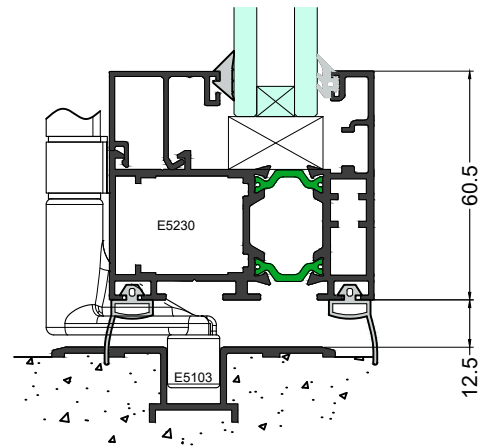

Alternative Sill

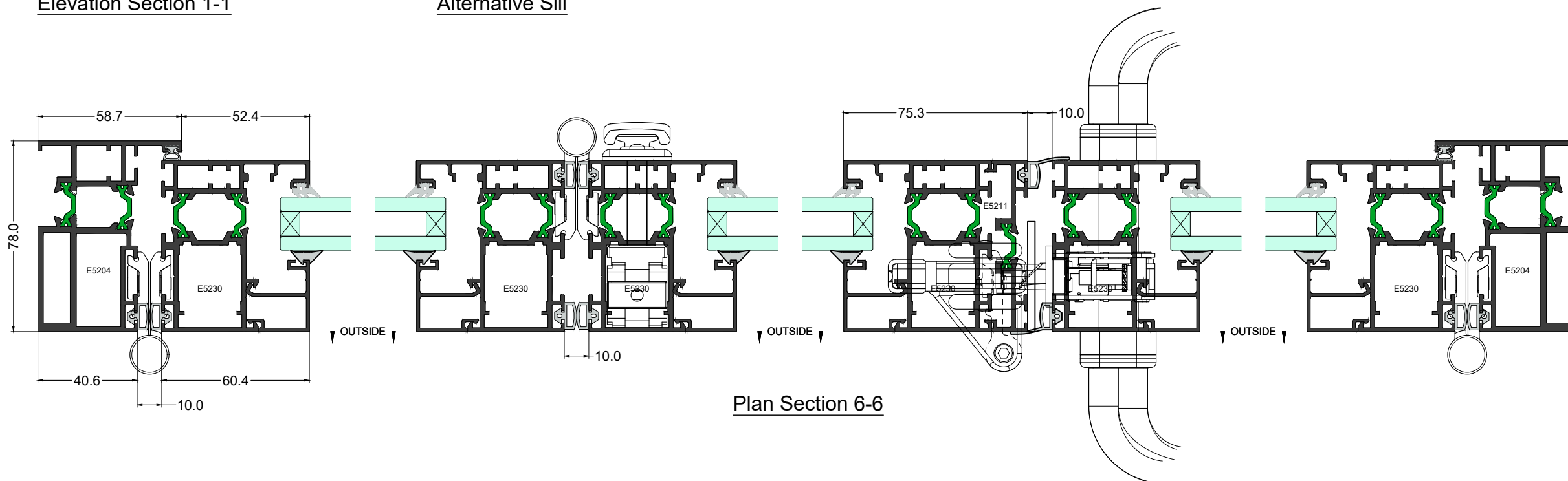
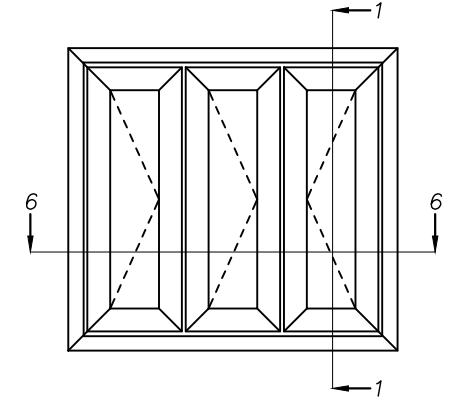

Plan Section 6-6

EC55TB

Layouts

BI-FOLD

(OPEN IN)

THERMECO™

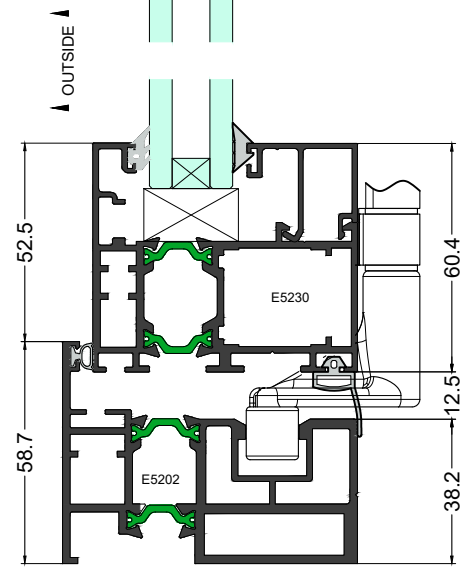
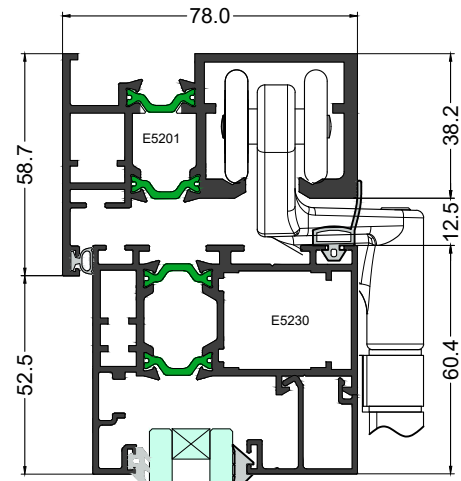

Elevation Section 1-1

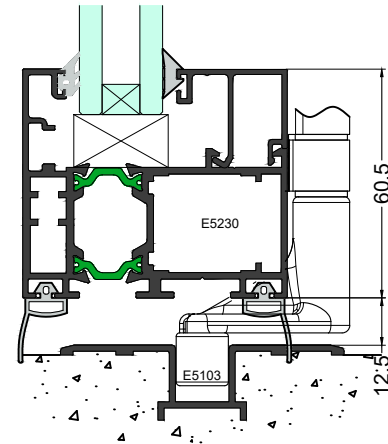

Alternative Sill

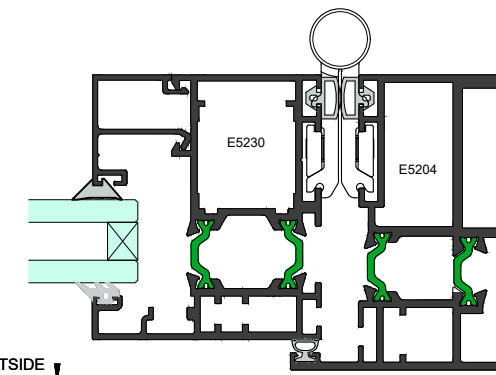
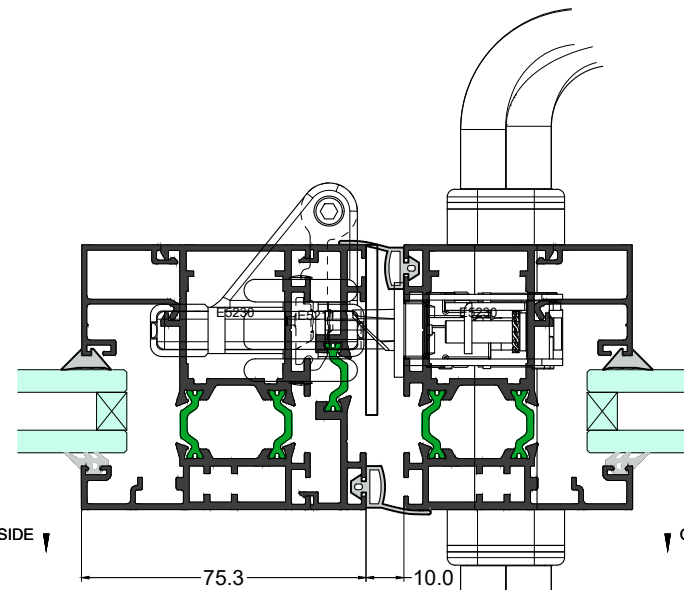
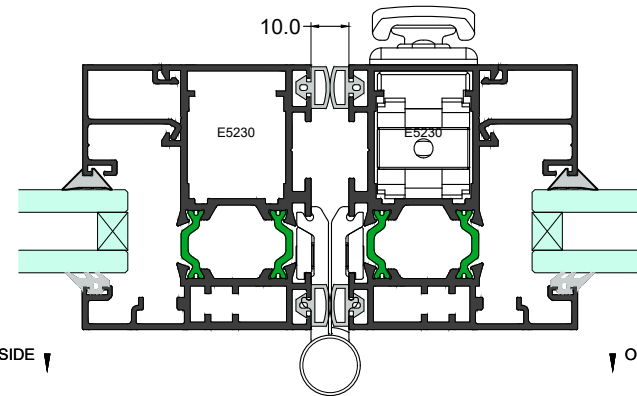
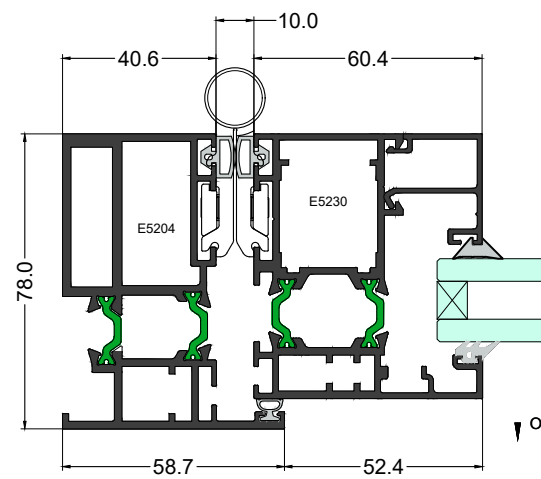
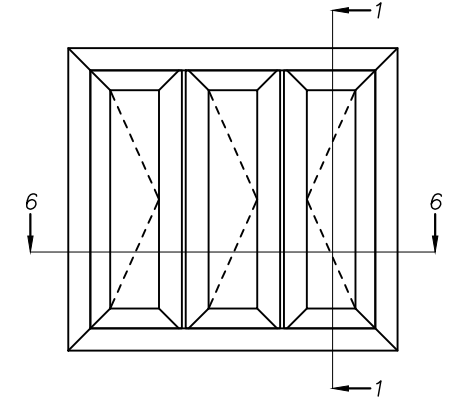

Plan Section 6-6